



T1 Bitte unbedingt ausfüllen!

Name	
Strasse	
Plz	Ort
Tel.	

T2 Sehr geehrte Kunden,
wir freuen uns, dass Sie sich für ein Produkt aus dem Hause Pelipalentschieden haben. Sollte es trotz aller Bemühungen unsererseits, Ihnen ein qualitativ hochwertiges Möbelstück zu liefern, zu Fehlteilen kommen, schicken Sie bitte dieses ausgefüllte Blatt an
Fax.: **+49 3443/434354**
E-Mail: **weissenfels.ersatzteile@pelipal.de**
Bitte beachten Sie, dass Bauteile über 800mm Länge und 350mm Breite direkt bei Ihrem Möbelhändler zu beanstanden sind. Zur Reklamationsbearbeitung ist es unbedingt erforderlich **die Artikelnummer des Schrankes**, welche auf dem Etikett ersichtlich ist und den Markt, wo das Möbel erworben wurde anzugeben. Ausserdem tragen Sie unten bitte die benötigte Stückzahl ein. Viel Spass mit Ihrem neuen Badmöbel! Ihr Pelipal Team

-

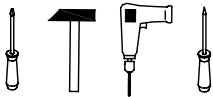

T3 Für den Zusammenbau sind 2 Personen erforderlich.

T4 Montage-Richtzeit 3 Stunden

16 x a DÜB-SMD-000005	Stück	16 x b EXZENTER-000015	Stück	4 x c ZPL-016X000	Stück	4 x d TBD-26-115X00	Stück	2 x e SCH-KA-M04X009	Stück
20 x f NAGEL-025X001	Stück	8 x g SCH-SPA-035X015	Stück	4 x h SCH-KA-063X010	Stück	12 x k TRÄ-001-000020	Stück	1 x l LEIM-00015G	Stück
3 x m Griff	Stück	6 x n Griffschraube	Stück	4 x p ADK-AL1-005X008	Stück	4 x r DÜB-HLZ-008X030	Stück		Stück
2 x s KA-246-1700	Stück		Stück		Stück		Stück		Stück

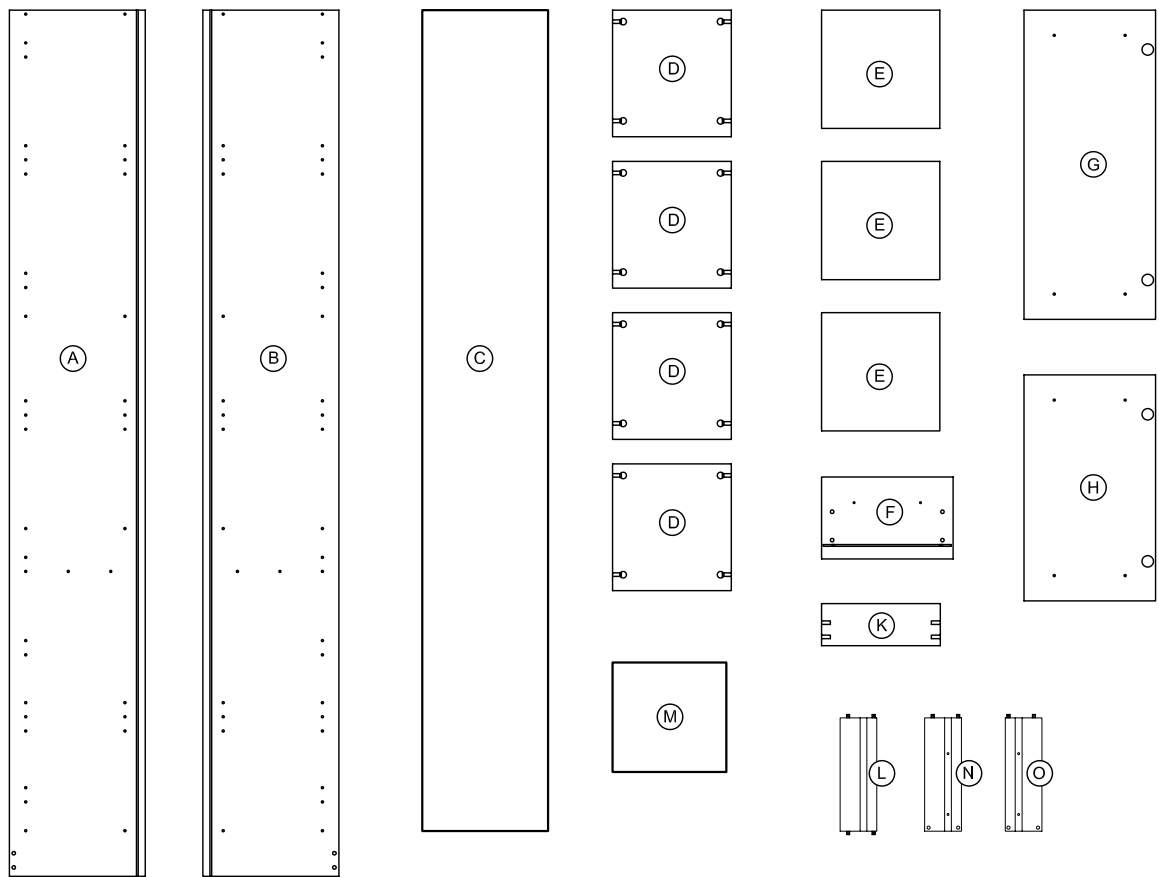

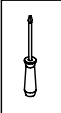
1. 

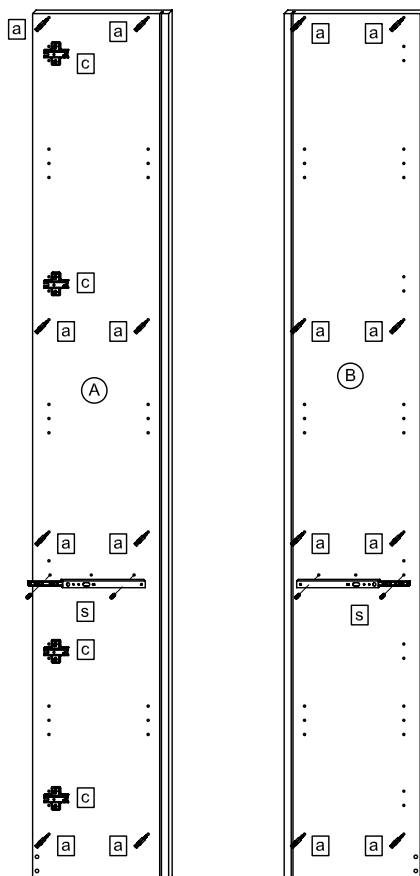
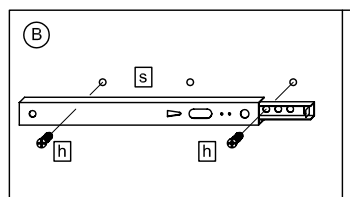
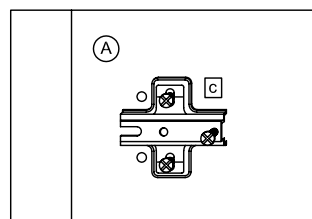

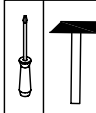
2. 

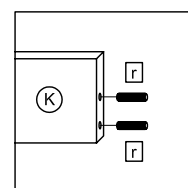
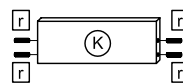
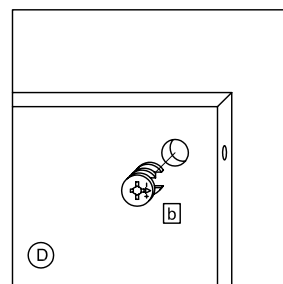
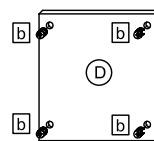

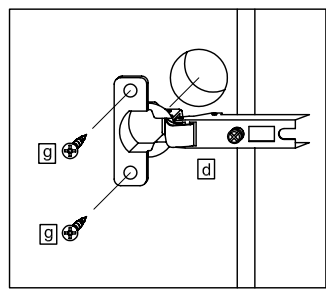
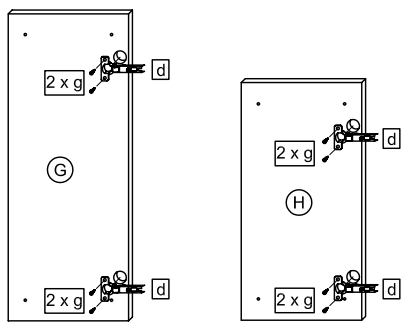
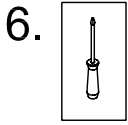
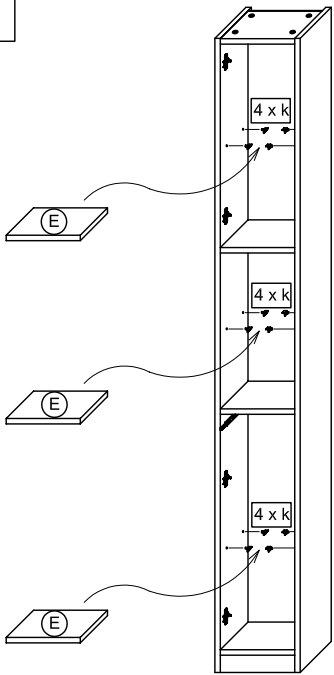
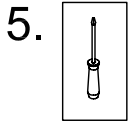
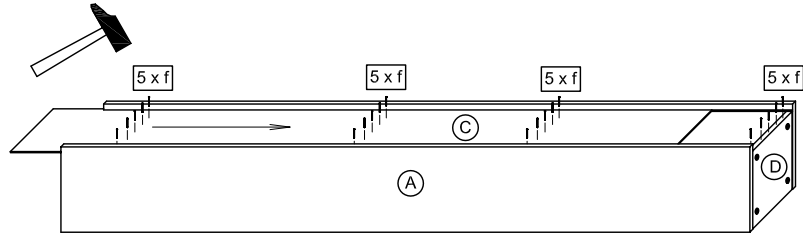
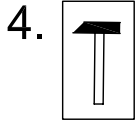
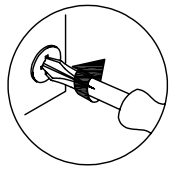
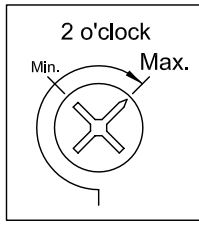
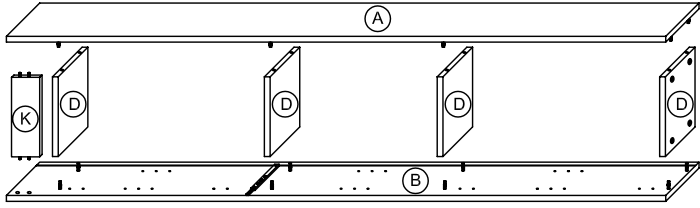
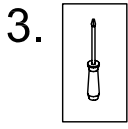

Das Etikett, welches sich unten rechts befindet bitte ausschneiden und auf der Rückwand mit Klebeband (nicht beiliegend) befestigen.

PELIPAL GmbH
 Industriestrasse 12
 33189 Schlangen

7.

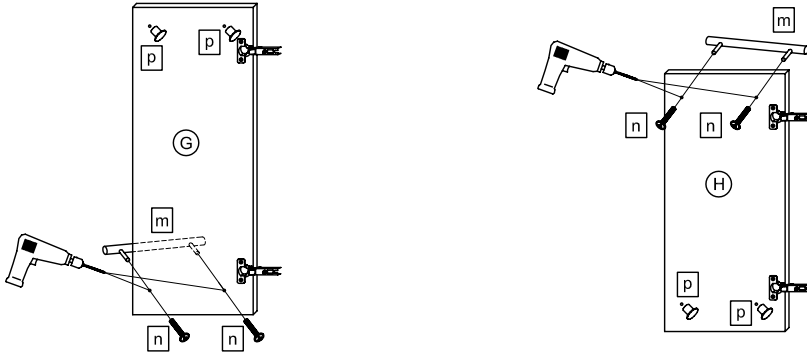
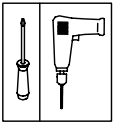

7.1

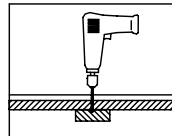
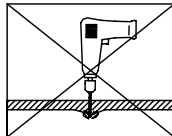

7.2



Bei Hochglanz-Fronten bitte erst die Schutzfolie entfernen und dann den Griff montieren!

7.3

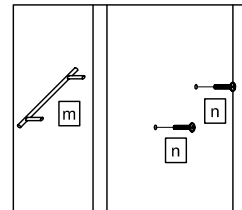

8.

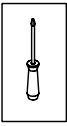

T11 Bei Türmontage das Scharnier einhängen, bis Anschlag öffnen und anschließend festschrauben.

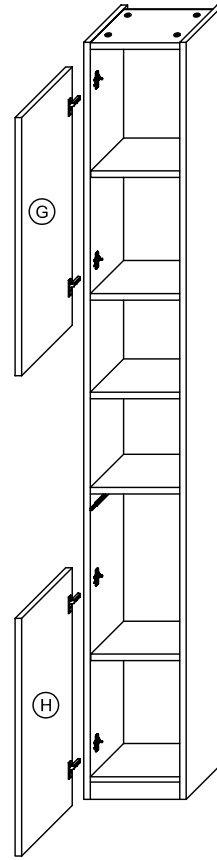
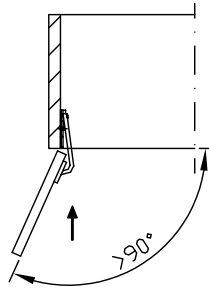
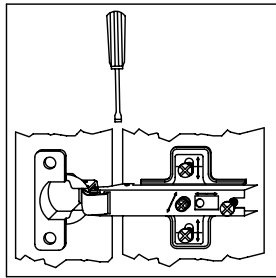

9.

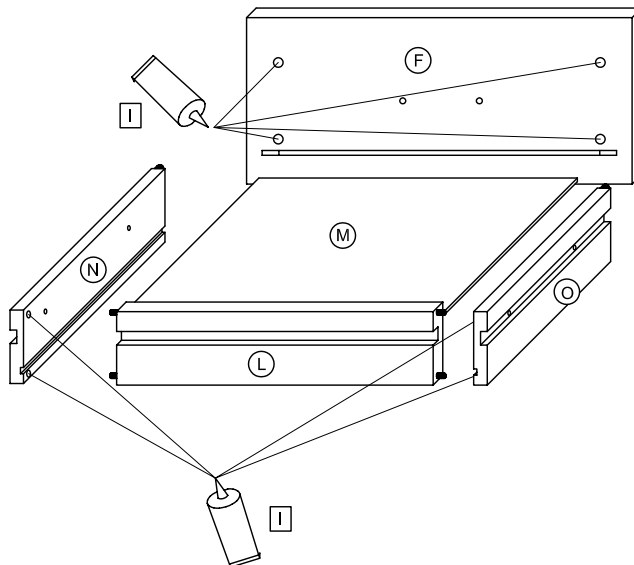

10.

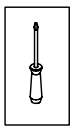

10.1

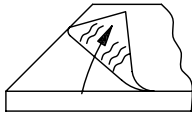

Bei Hochglanz-Fronten bitte erst die Schutzfolie entfernen und dann den Griff montieren!

10.2

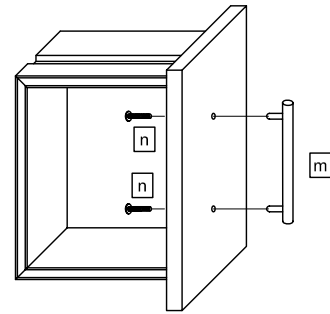

11.

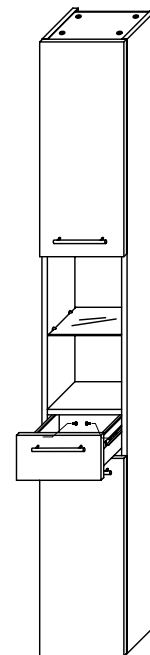
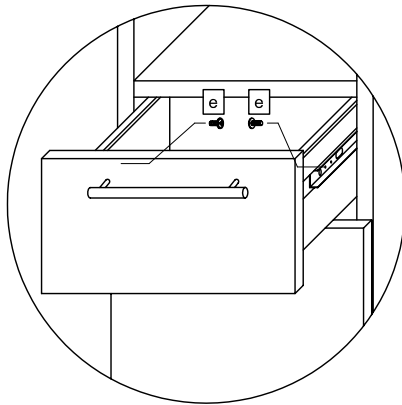
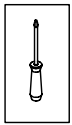

Das Möbel bitte nur mit einem feuchten Tuch reinigen.

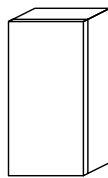

T1 Bitte unbedingt ausfüllen!

Name _____

Strasse _____

Plz _____ Ort _____





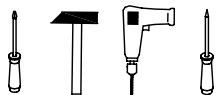



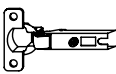

Tel. _____

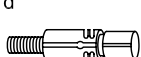
T2 Sehr geehrte Kunden,
wir freuen uns, dass Sie sich für ein Produkt aus dem Hause Pelipalentschieden haben. Sollte es trotz aller Bemühungen unsererseits, Ihnen ein qualitativ hochwertiges Möbelstück zu liefern, zu Fehlteilen kommen, schicken Sie bitte dieses ausgefüllte Blatt an
Fax.: **+49 3443/434354**
E-Mail: **weissenfels.ersatzteile@pelipal.de**
Bitte beachten Sie, dass Bauteile über 800mm Länge und 350mm Breite direkt bei Ihrem Möbelhändler zu beanstanden sind. Zur Reklamationsbearbeitung ist es unbedingt erforderlich **die Artikelnummer des Schrankes**, welche auf dem Etikett ersichtlich ist und den Markt, wo das Möbel erworben wurde anzugeben. Ausserdem tragen Sie unten bitte die benötigte Stückzahl ein. Viel Spass mit Ihrem neuen Badmöbel! Ihr Pelipal Team

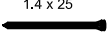
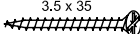

T3 Für den Zusammenbau sind 2 Personen erforderlich.

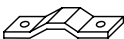
T4 Montage-Richtzeit 3 Stunden

2 x a  TBD-26-115X00	Stück	2 x b  ZPL-016X000	Stück	4 x c  SCH-SPA-035X015	Stück	8 x d  DÜB-SMD-000005	Stück	8 x e  EXZENTER-000015	Stück
1 x f  Griff	Stück	1 x g  Griffschrauben	Stück	8 x h  NAGEL-025X001	Stück	4 x j  SCH-SPA-035X035	Stück	8 x k  TRÄ-001-000020	Stück
1 x l  ADK-AL1-005X008	Stück	2 x m  AUF-001-000010	Stück	2 x n  AUF-001-000020	Stück		Stück		Stück

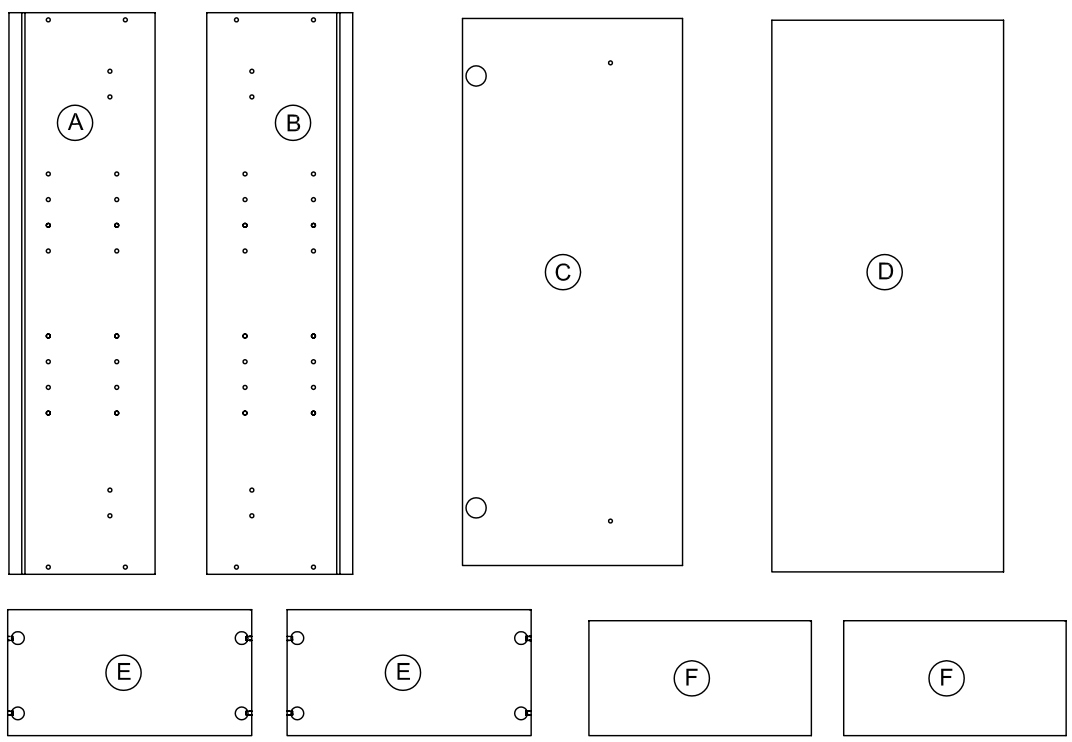

1.

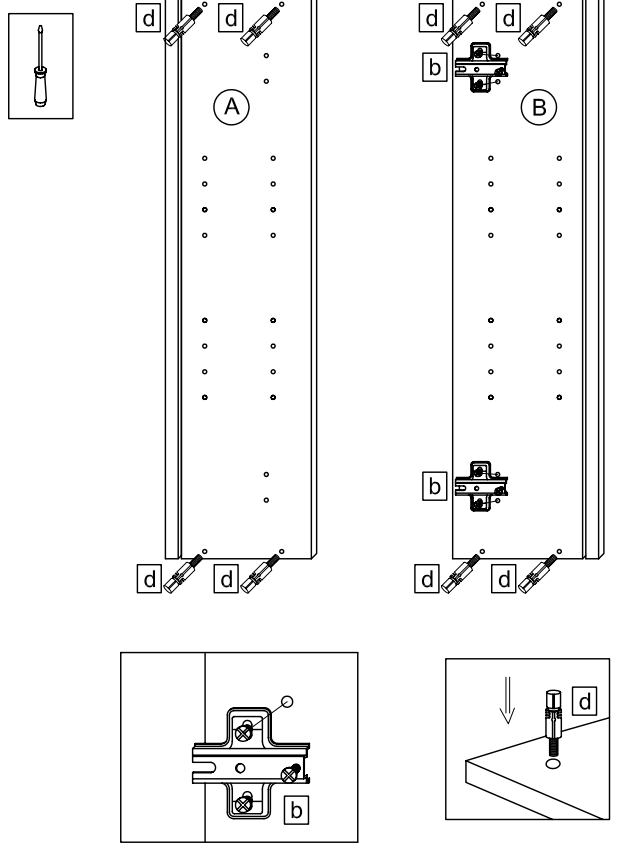

3.

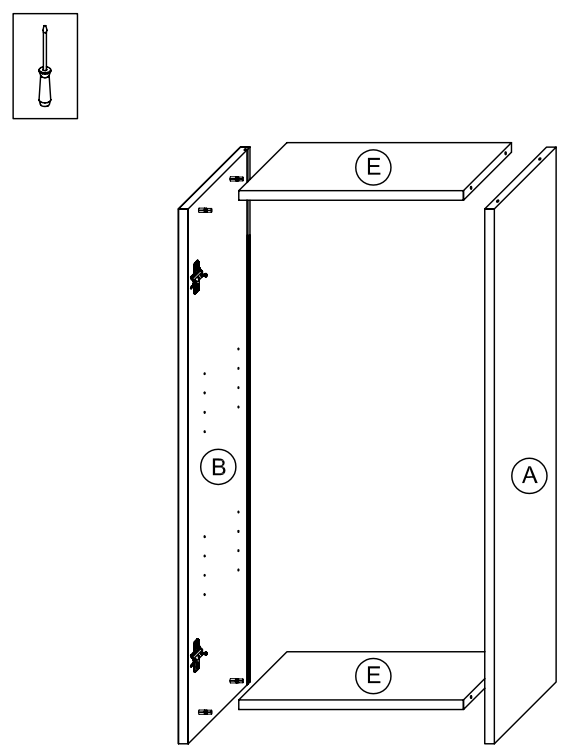

2.

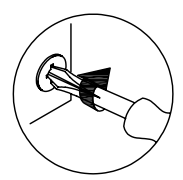
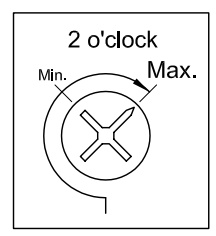
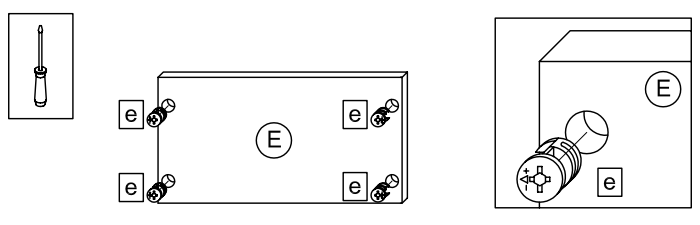

4.

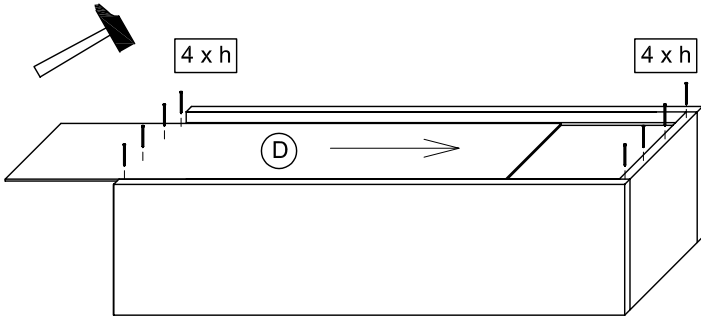
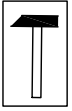

5.

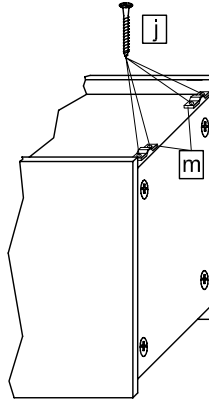
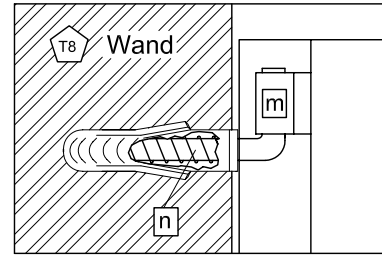
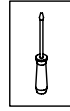

T9 Lassen Sie den Schrank nur durch fachkundige Personen mit für die Wand geeignetem Montagematerialien montieren.

6.

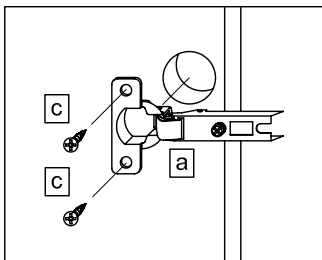
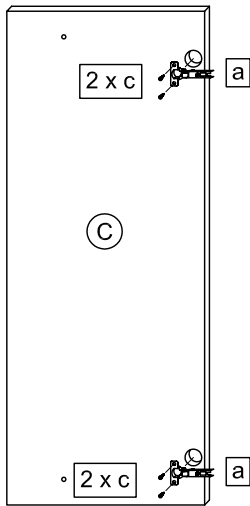
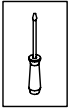

7.

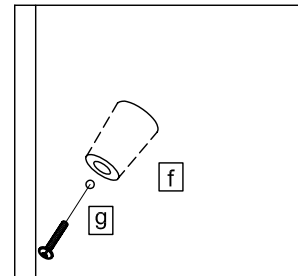
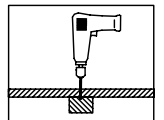
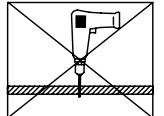
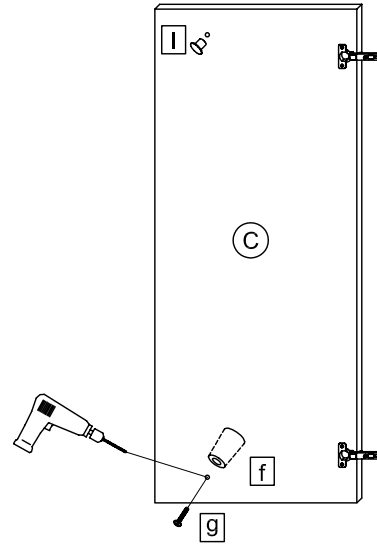
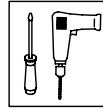

T5 Das Etikett, welches sich unten rechts befindet bitte ausschneiden und auf der Rückwand mit Klebeband (nicht beiliegend) befestigen.



PELIPAL GmbH
 Industriestrasse 12
 33189 Schlangen
 Germany

8.

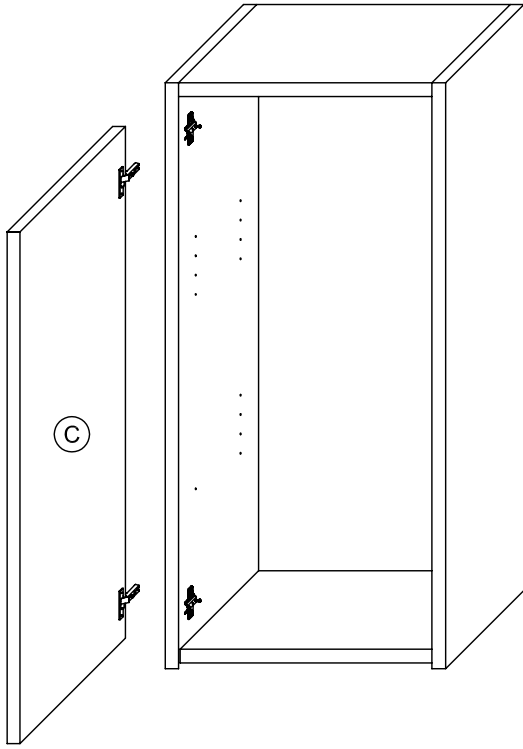
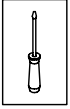

T11

Bei Türmontage das Scharnier einhängen, bis Anschlag öffnen und anschließend festschrauben.

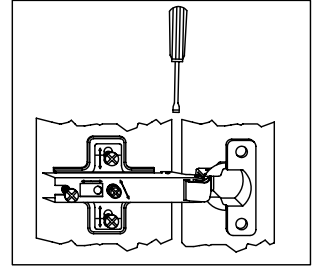
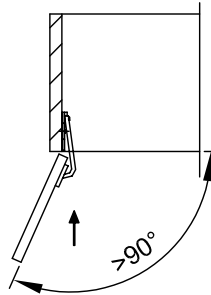

9.

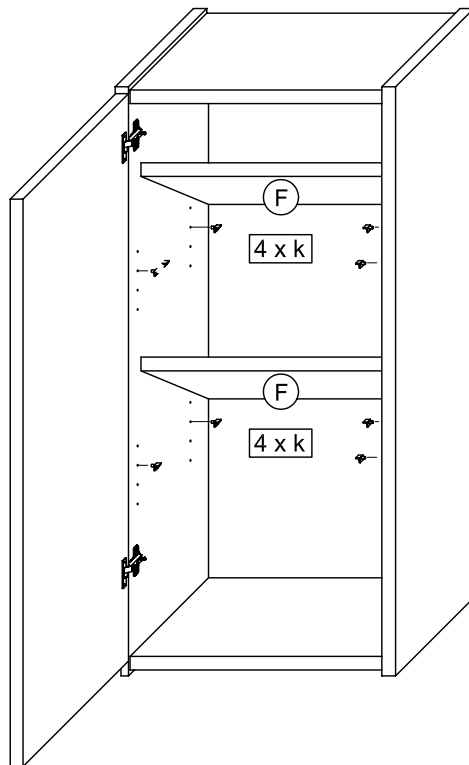

T12

Das Möbel bitte nur mit einem feuchten Tuch reinigen.

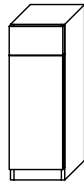

T1 Bitte unbedingt ausfüllen!

Name _____

Strasse _____

Plz _____ Ort _____





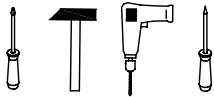





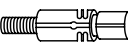

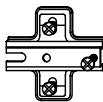
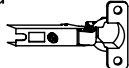
Tel. _____

T2 Sehr geehrte Kunden,
wir freuen uns, dass Sie sich für ein Produkt aus dem Hause Pelipalentschieden haben. Sollte es trotz aller Bemühungen unsererseits, Ihnen ein qualitativ hochwertiges Möbelstück zu liefern, zu Fehlteilen kommen, schicken Sie bitte dieses ausgefüllte Blatt an
Fax.: **+49 3443/434354**
E-Mail: **weissenfels.ersatzteile@pelipal.de**
Bitte beachten Sie, dass Bauteile über 800mm Länge und 350mm Breite direkt bei Ihrem Möbelhändler zu beanstanden sind. Zur Reklamationsbearbeitung ist es unbedingt erforderlich **die Artikelnummer des Schrankes**, welche auf dem Etikett ersichtlich ist und den Markt, wo das Möbel erworben wurde anzugeben. Ausserdem tragen Sie unten bitte die benötigte Stückzahl ein. Viel Spass mit Ihrem neuen Badmöbel! Ihr Pelipal Team

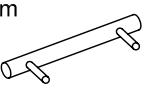

T3 Für den Zusammenbau sind 2 Personen erforderlich.

T4 Montage-Richtzeit 3 Stunden

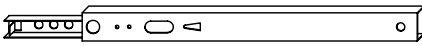
8 x a  DÜB-SMD-000005	Stück	8 x b  EXZENTER-000015	Stück	2 x c  ZPL-016X000	Stück	2 x d  TBD-26-115X00	Stück	2 x e  SCH-KA-M04X009	Stück
5 x f  NAGEL-025X001	Stück	4 x g  SCH-SPA-035X015	Stück	4 x h  SCH-KA-063X010	Stück	4 x k  TRÄ-001-000020	Stück	1 x l  LEIM-00015G	Stück
2 x m  Griff	Stück	4 x n  Griffschraube	Stück	2 x p  ADK-AL1-005X008	Stück	4 x r  DÜB-HLZ-008X030	Stück		Stück
2 x s  KA-246-1700	Stück		Stück		Stück		Stück		Stück

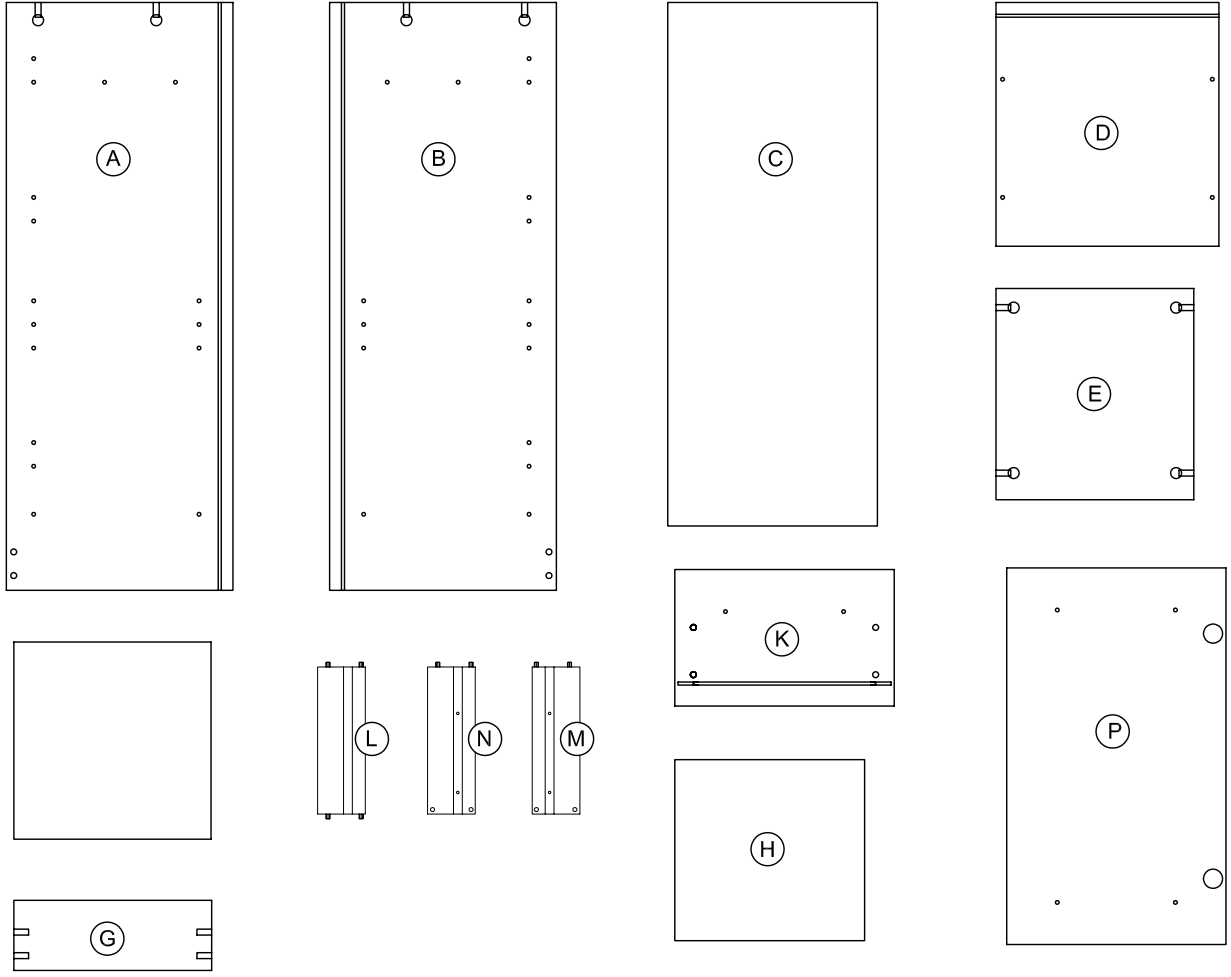

1. 

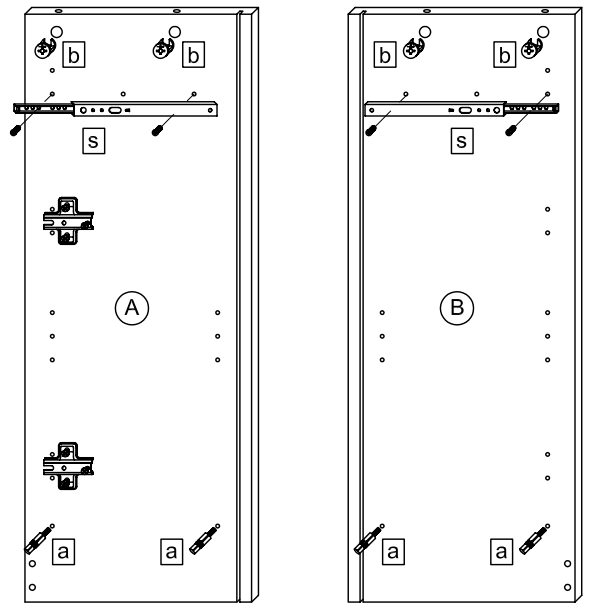
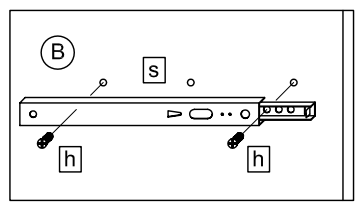

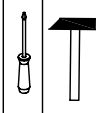
2. 

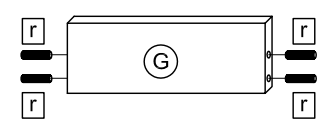
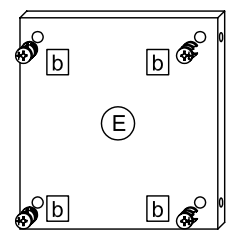
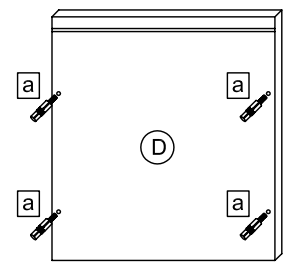

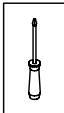
3. 

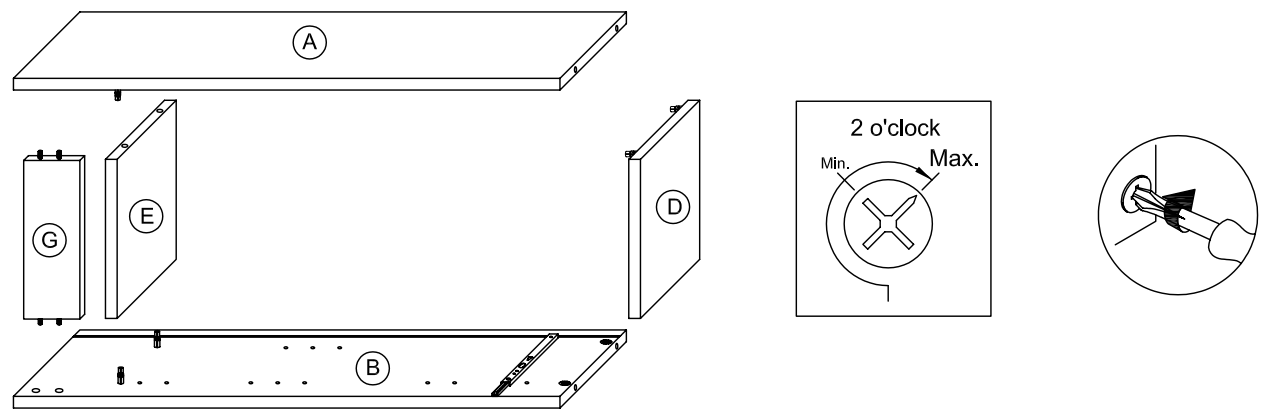

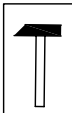
4. 

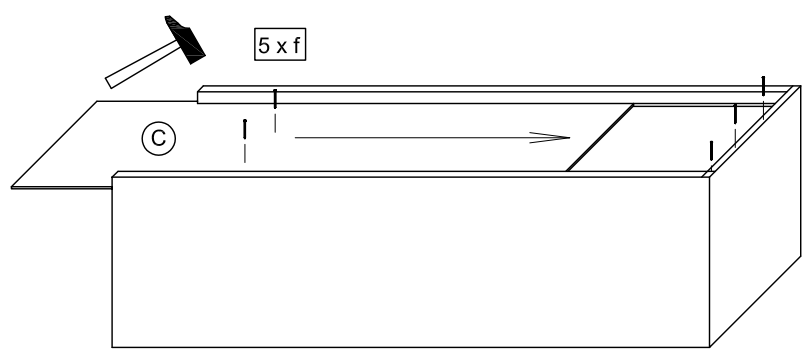

 Das Etikett, welches sich unten rechts befindet bitte ausschneiden und auf der Rückwand mit Klebeband (nicht beiliegend) befestigen.



PELIPAL GmbH
Industriestrasse 12
33189 Schlangen

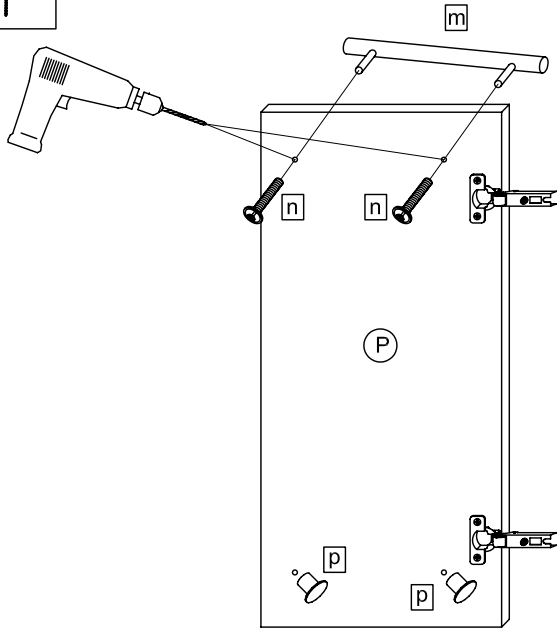
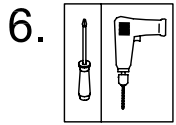
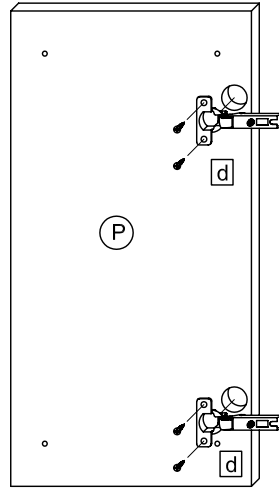
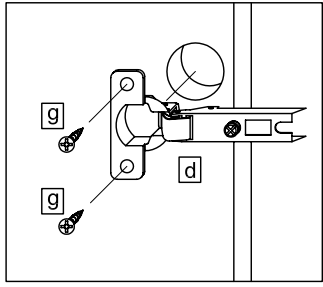
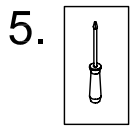

6.1

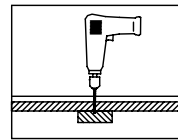
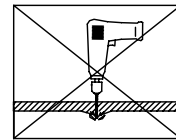

6.2

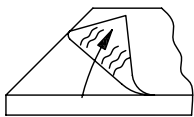

Bei Hochglanz-Fronten bitte erst die Schutzfolie entfernen und dann den Griff montieren!

6.3

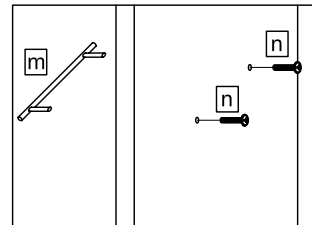

7.

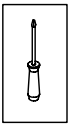

T11 Bei Türmontage das Scharnier einhängen, bis Anschlag öffnen und anschließend festschrauben.

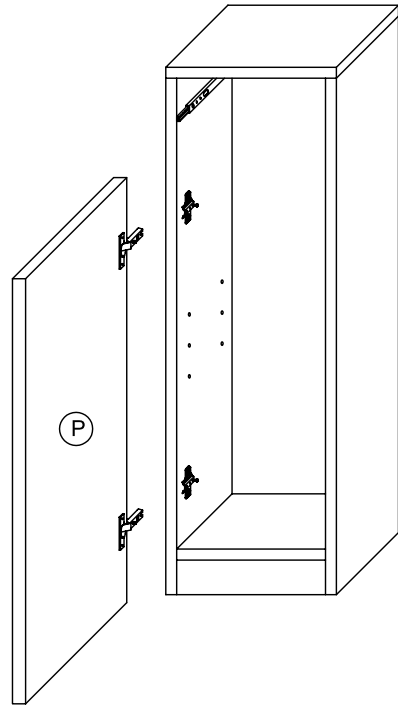
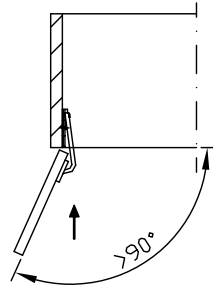
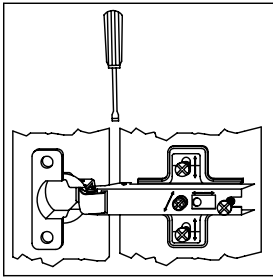

8.

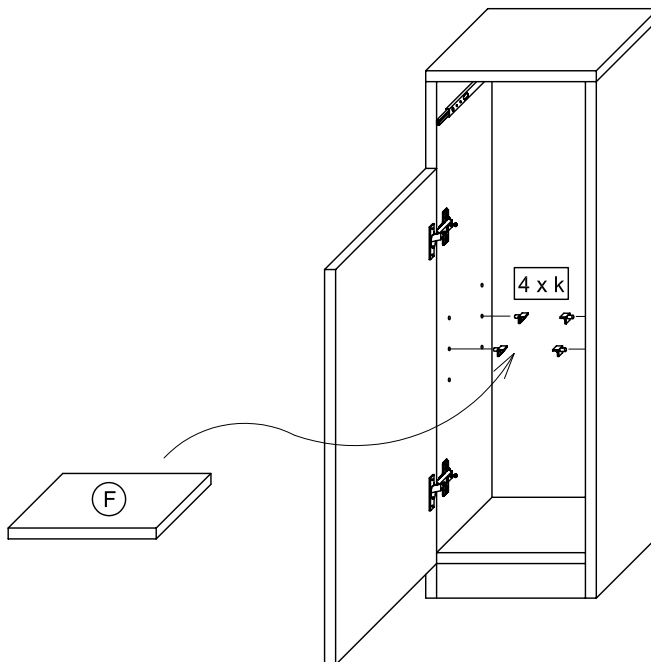

9.

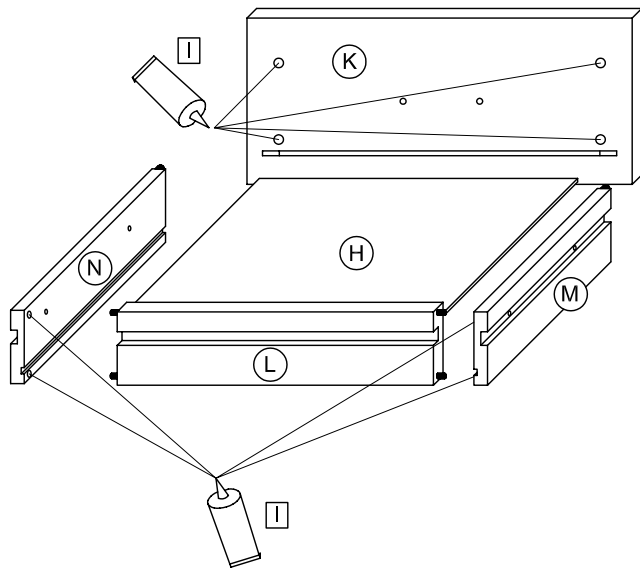

10.

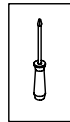

10.1

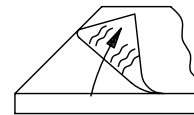

Bei Hochglanz-Fronten bitte erst die Schutzfolie entfernen und dann den Griff montieren!

10.2

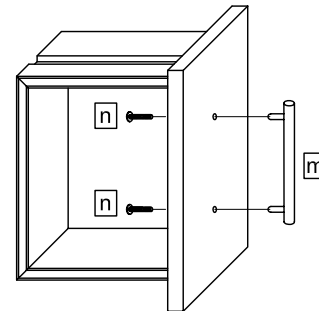

11.

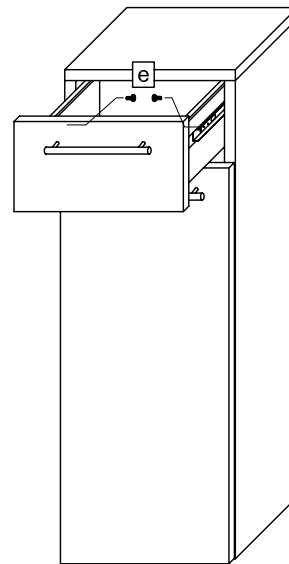
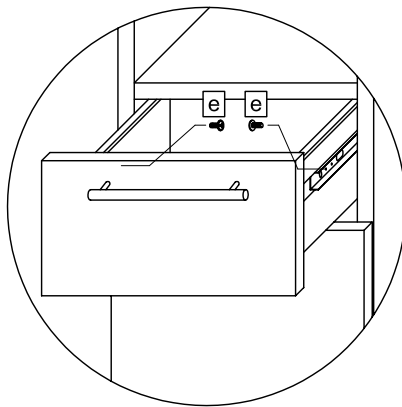
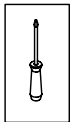

Das Möbel bitte nur mit einem feuchten Tuch reinigen.

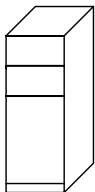

T1 Bitte unbedingt ausfüllen!

Name _____

Strasse _____

Plz _____ Ort _____

Tel. _____

T2 Sehr geehrte Kunden,
wir freuen uns, dass Sie sich für ein Produkt aus dem Hause Pelipalentschieden haben. Sollte es trotz aller Bemühungen unsererseits, Ihnen ein qualitativ hochwertiges Möbelstück zu liefern, zu Fehlteilen kommen, schicken Sie bitte dieses ausgefüllte Blatt an
Fax.: **+49 3443/434354**
E-Mail: **weissenfels.ersatzteile@pelipal.de**
Bitte beachten Sie, dass Bauteile über 800mm Länge und 350mm Breite direkt bei Ihrem Möbelhändler zu beanstanden sind. Zur Reklamationsbearbeitung ist es unbedingt erforderlich **die Artikelnummer des Schrankes**, welche auf dem Etikett ersichtlich ist und den Markt, wo das Möbel erworben wurde anzugeben. Ausserdem tragen Sie unten bitte die benötigte Stückzahl ein. Viel Spass mit Ihrem neuen Badmöbel! Ihr Pelipal Team

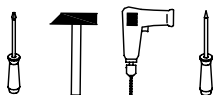

T3 Für den Zusammenbau sind 2 Personen erforderlich.

T4 Montage-Richtzeit 3 Stunden

12 x a DÜB-SMD-000005	Stück	12 x b EXZENTER-000015	Stück	2 x c TBD-26-115X00	Stück	2 x d ZPL-016X000	Stück
4 x e TRÄ-001-000020	Stück	4 x f DÜB-HLZ-008X030	Stück	2 x g ADK-AL1-005X008	Stück	4 x h SCH-SPA-035X015	Stück
8 x k SCH-KA-063X010	Stück	4 x l SCH-KA-M04X009	Stück	1 x m LEIM-00015G	Stück	10 x n NAGEL-025X001	Stück
3 x p GRI-160-335010	Stück	6 x r SCH-KNO-M04X024	Stück	2 x s KA-246-1700	Stück		Stück

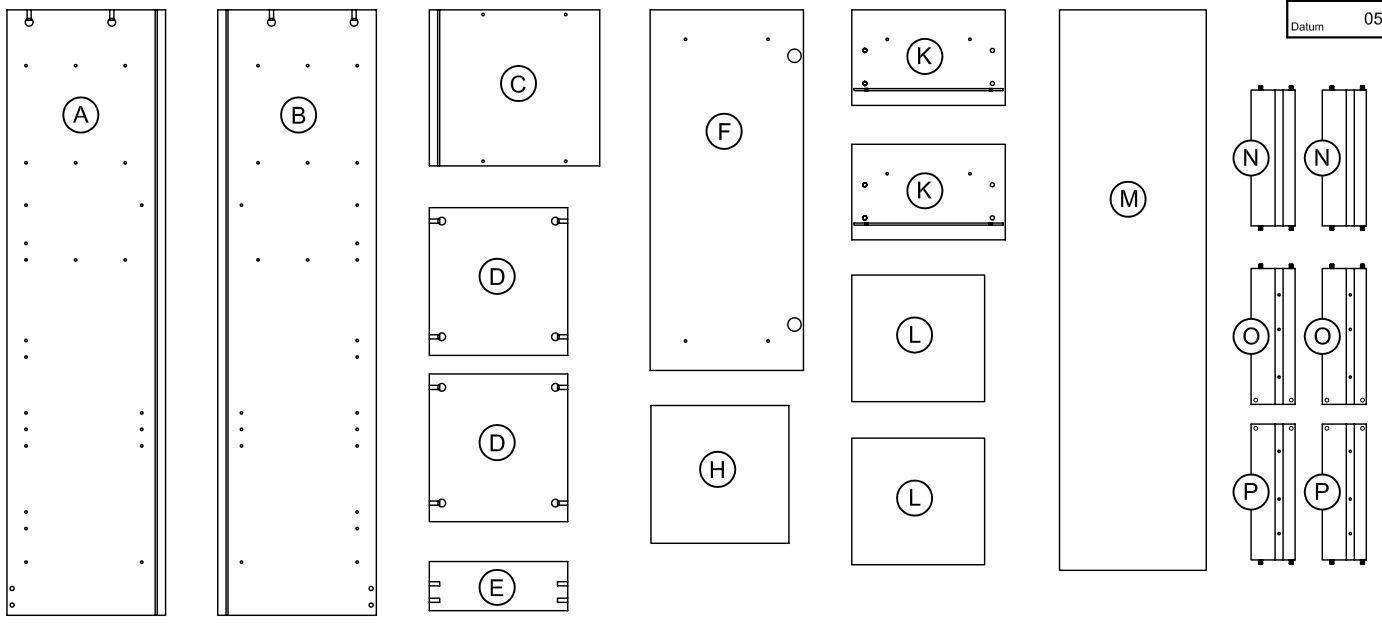

1.

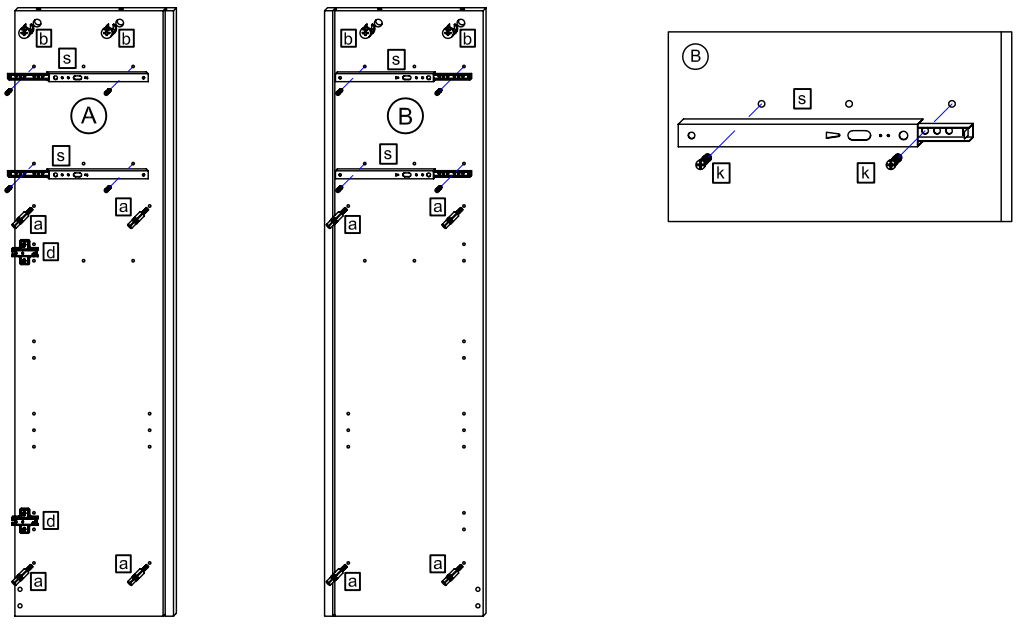
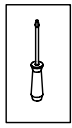

2.

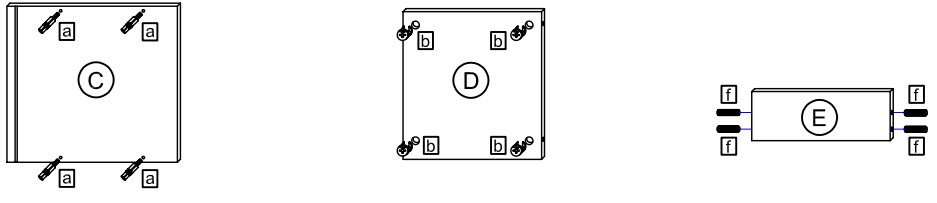
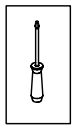

3.

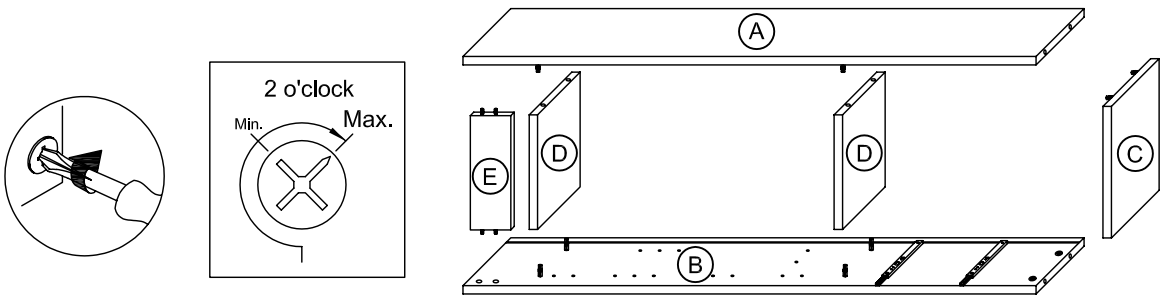
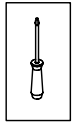

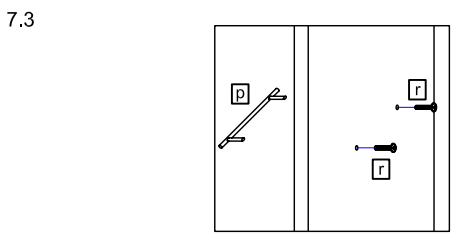
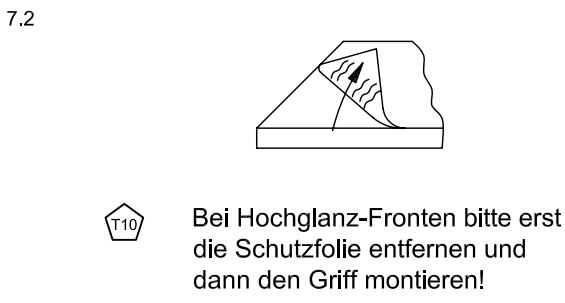
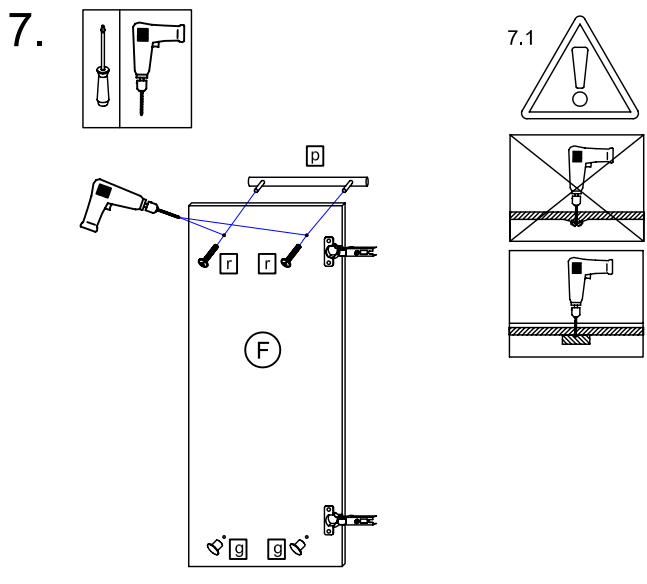
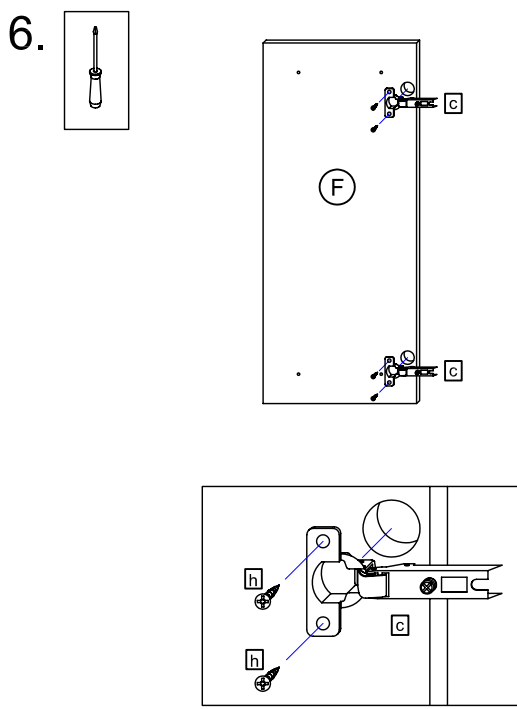
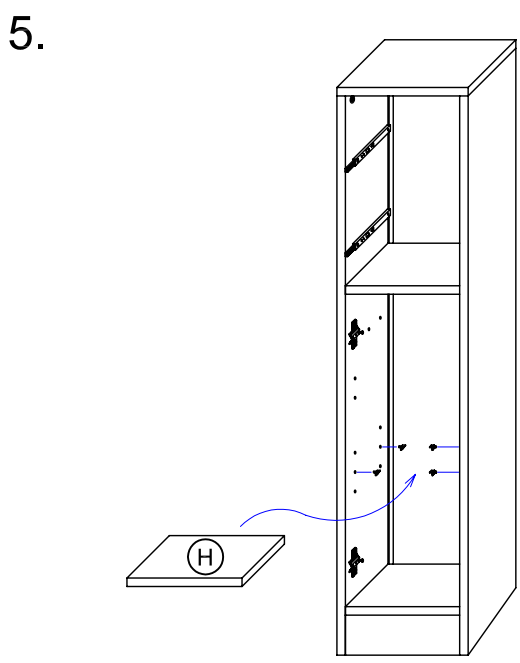
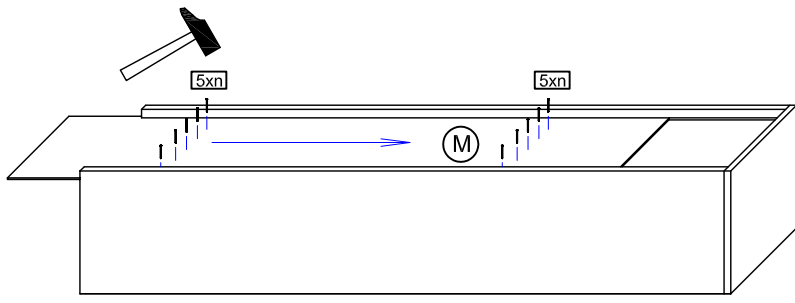
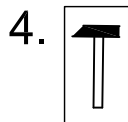

Das Etikett, welches sich unten rechts befindet bitte ausschneiden und auf der Rückwand mit Klebeband (nicht beiliegend) befestigen.



PELIPAL GmbH
 Industriestrasse 12
 33189 Schlangen

8.

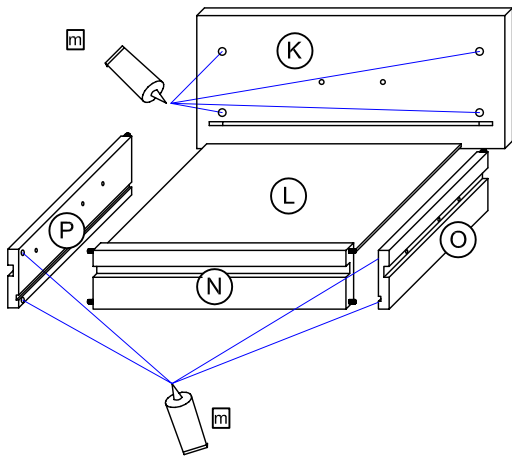

9.

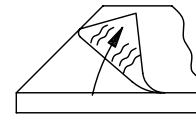
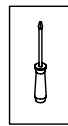

9.1



Bei Hochglanz-Fronten bitte erst die Schutzfolie entfernen und dann den Griff montieren!

9.2

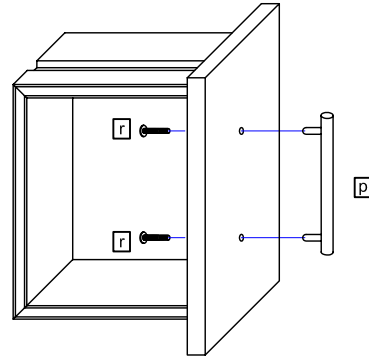

10.

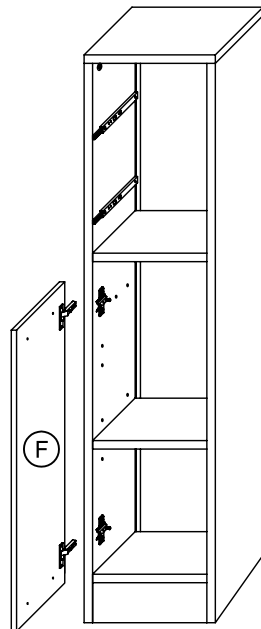
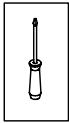

Bei Türmontage das Scharnier einhängen, bis Anschlag öffnen und anschließend festschrauben.

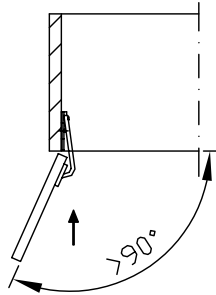
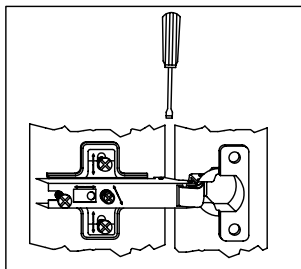

11.

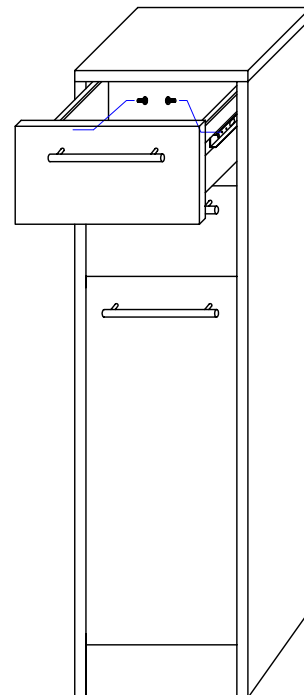
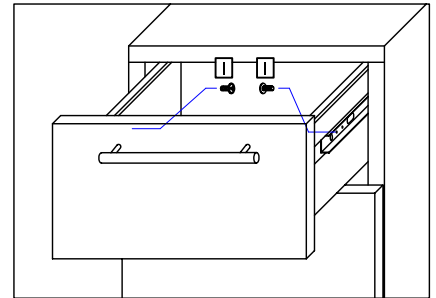
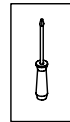

Das Möbel bitte nur mit einem feuchten Tuch reinigen.

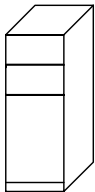

T1 Bitte unbedingt ausfüllen!

Name _____

Strasse _____

Plz _____ Ort _____

Tel. _____

T2 Sehr geehrte Kunden,
wir freuen uns, dass Sie sich für ein Produkt aus dem Hause Pelipal entschieden haben. Sollte es trotz aller Bemühungen unsererseits, Ihnen ein qualitativ hochwertiges Möbelstück zu liefern, zu Fehlteilen kommen, schicken Sie bitte dieses ausgefüllte Blatt an
Fax.: **+49 3443/434354**
E-Mail: **weisenfels.ersatzteile@pelipal.de**

Bitte beachten Sie, dass Bauteile über 800mm Länge und 350mm Breite direkt bei Ihrem Möbelhändler zu beanstanden sind. Zur Reklamationsbearbeitung ist es unbedingt erforderlich **die Artikelnummer des Schrankes**, welche auf dem Etikett ersichtlich ist und den Markt, wo das Möbel erworben wurde anzugeben. Ausserdem tragen Sie unten bitte die benötigte Stückzahl ein. Viel Spass mit Ihrem neuen Badmöbel! Ihr Pelipal Team

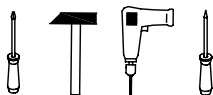

T3 Für den Zusammenbau sind 2 Personen erforderlich.

T4 Montage-Richtzeit 3 Stunden

12 x a DÜB-SMD-000005	Stück	12 x b EXZENTER-000015	Stück	2 x c TBD-26-115X00	Stück	2 x d ZPL-016X000	Stück
1 x e KLAPPENH-000010	Stück	4 x f DÜB-HLZ-008X030	Stück	6 x g SCH-RDK-040X015	Stück	8 x h SCH-SPA-035X015	Stück
8 x k SCH-KA-063X010	Stück	4 x l SCH-KA-M04X009	Stück	1 x m LEIM-00015G	Stück	10 x n NAGEL-025X001	Stück
3 x p GRI-160-335010	Stück	6 x r SCH-KNO-M04X024	Stück	2 x s KA-246-1700	Stück	1 x t WSK-WEI-220X270X600	Stück

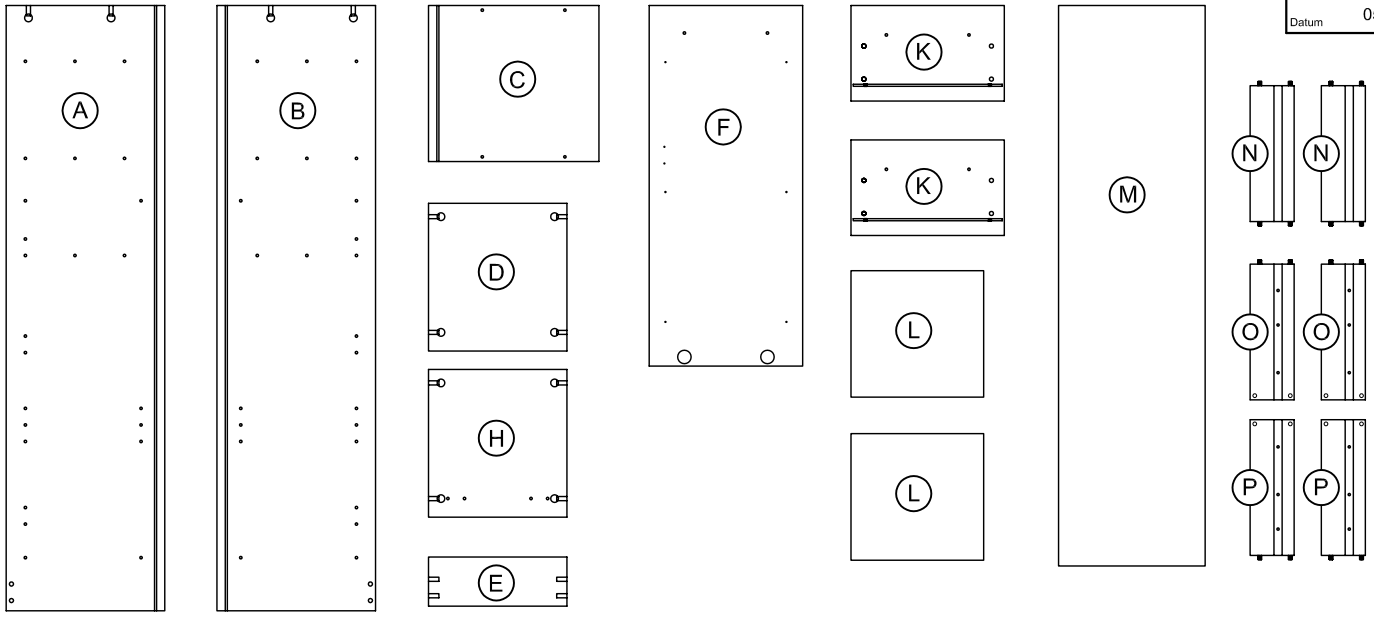

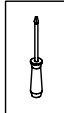
1. 

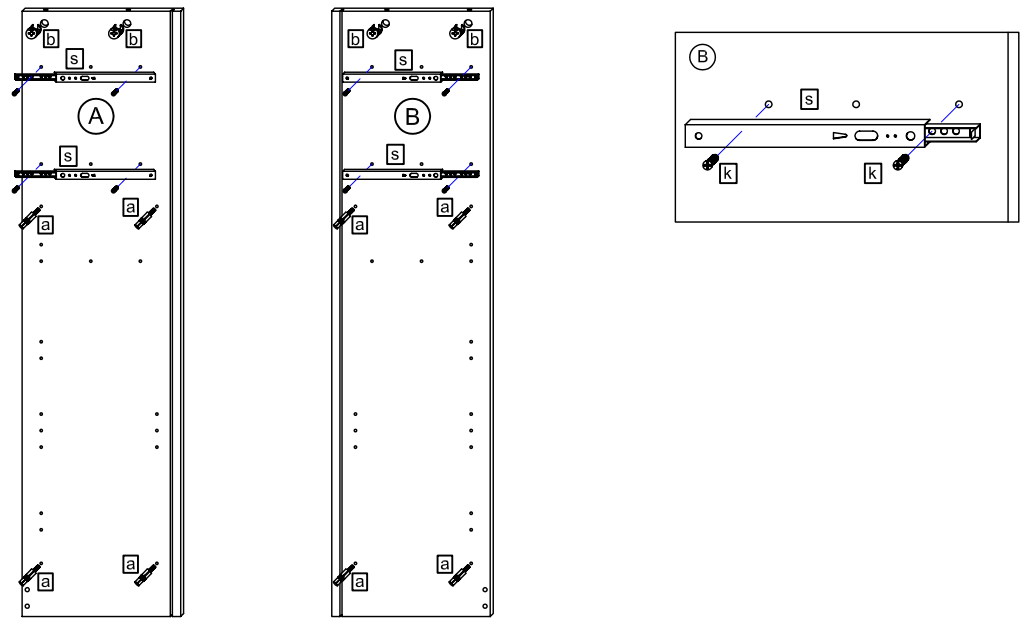

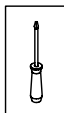
2. 

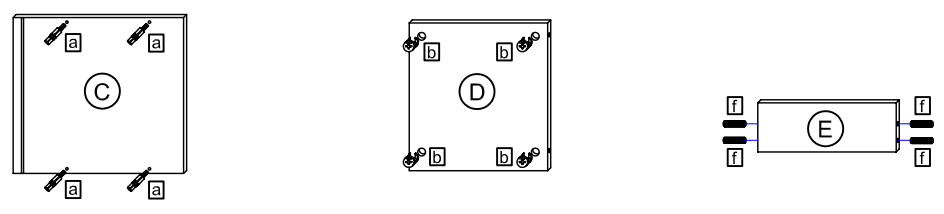

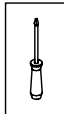
3. 

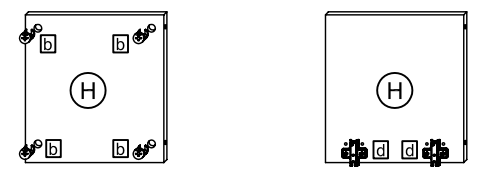

4.

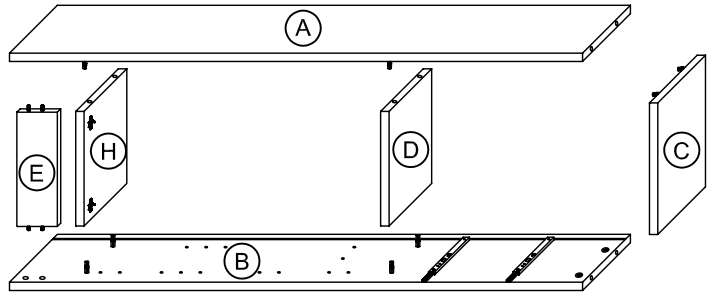
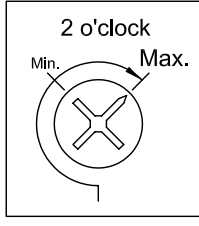
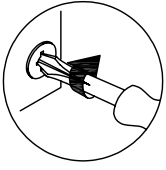
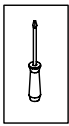

5.

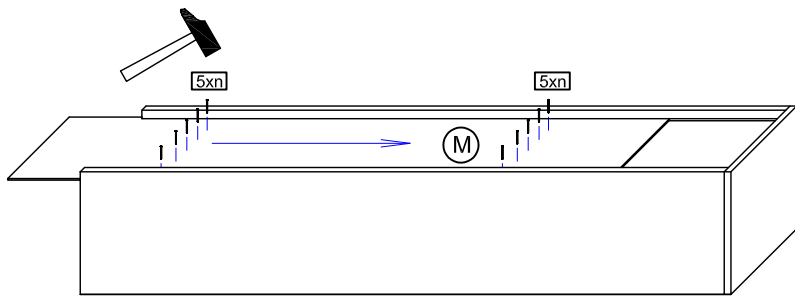
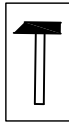

6.

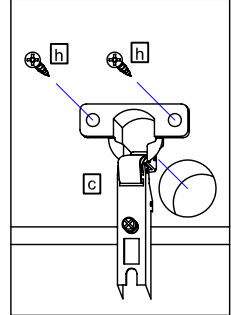
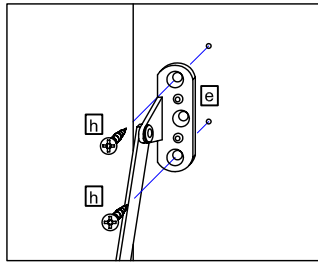
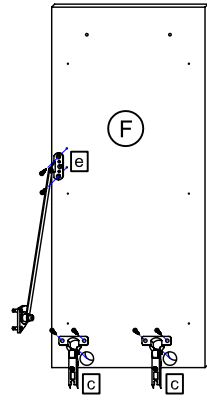
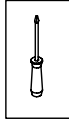

Das Etikett, welches sich unten rechts befindet bitte ausschneiden und auf der Rückwand mit Klebeband (nicht beiliegend) befestigen.

PELIPAL GmbH
 Industriestrasse 12
 33189 Schlangen

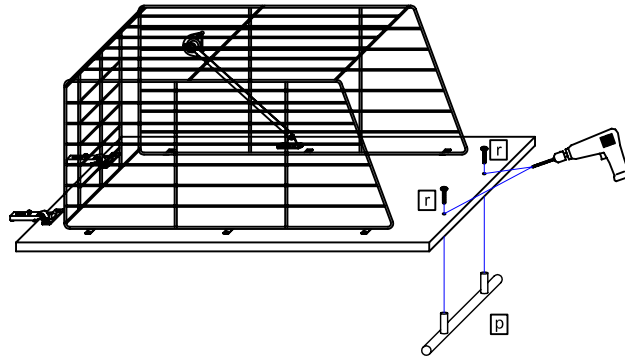
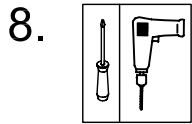
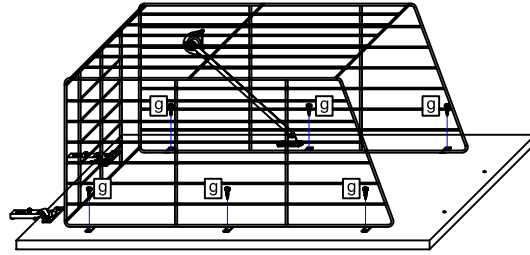
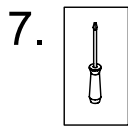

8.1

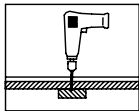
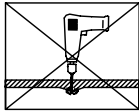

8.2

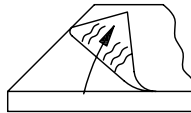

Bei Hochglanz-Fronten bitte erst die Schutzfolie entfernen und dann den Griff montieren!

8.3

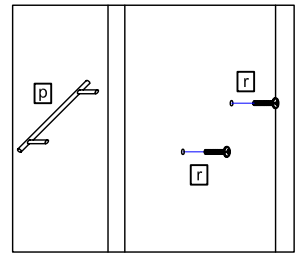

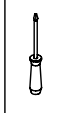
9. 

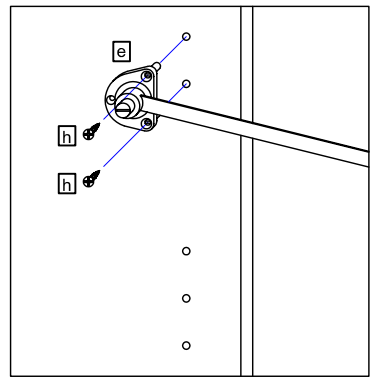
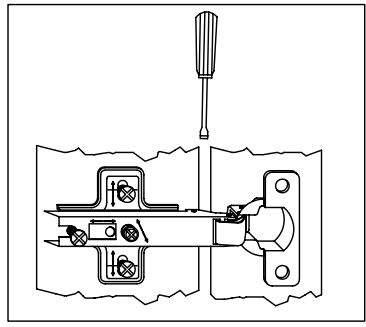
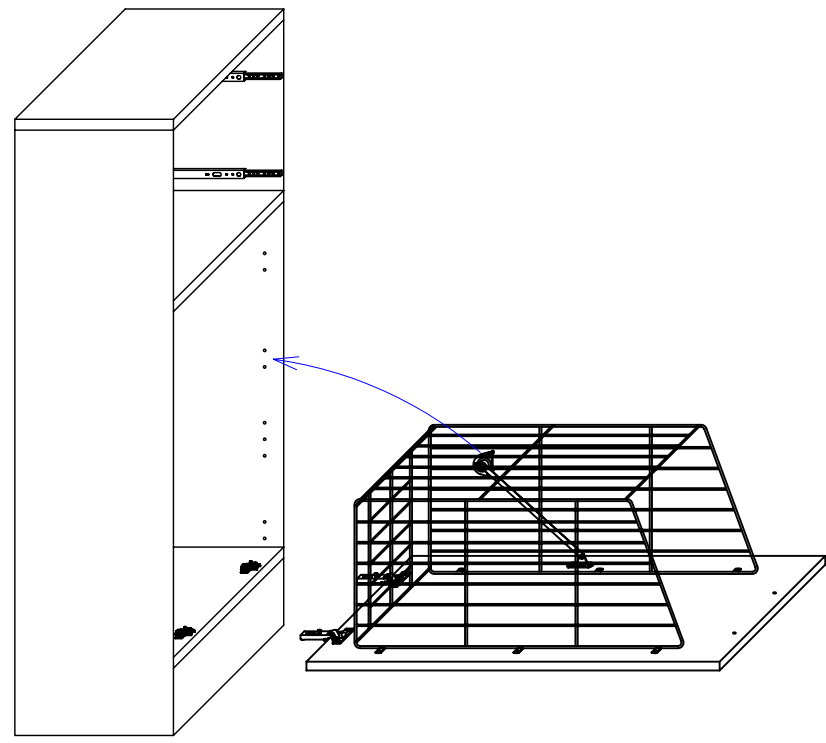

10.

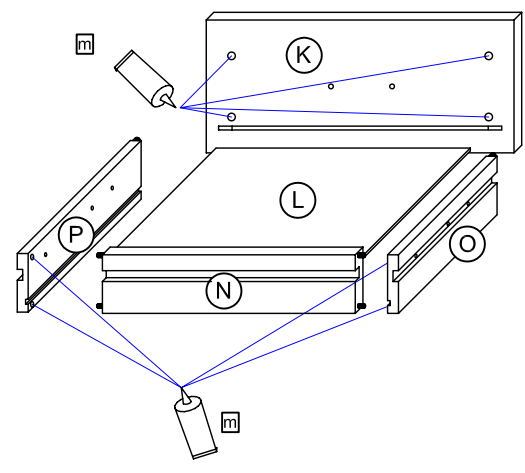

11.

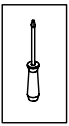

11.1

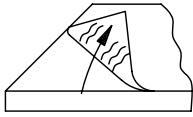

Bei Hochglanz-Fronten bitte erst die Schutzfolie entfernen und dann den Griff montieren!

11.2

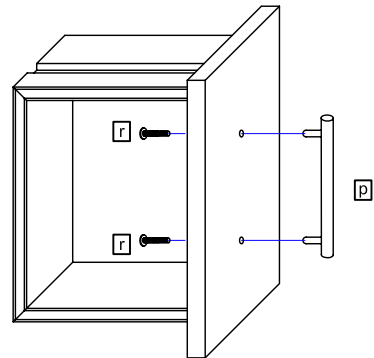

12.

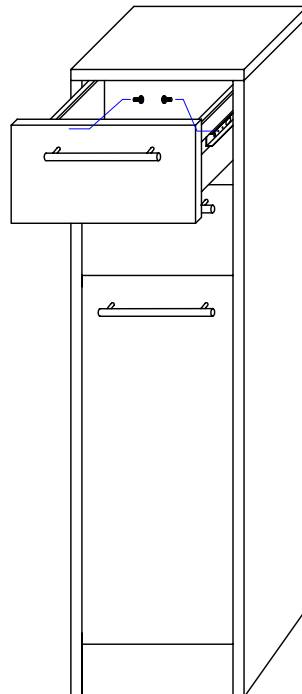
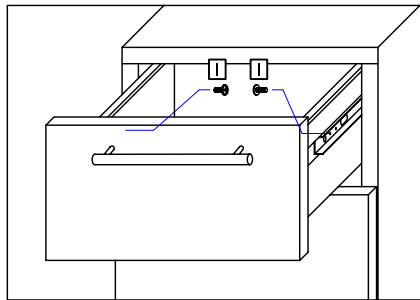
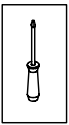

Das Möbel bitte nur mit einem feuchten Tuch reinigen.



T1 Bitte unbedingt ausfüllen!

Name _____

Strasse _____

Plz _____ Ort _____

Tel. _____

T2 Sehr geehrte Kunden,
wir freuen uns, dass Sie sich für ein Produkt aus dem Hause Pelipalentschieden haben. Sollte es trotz aller Bemühungen unsererseits, Ihnen ein qualitativ hochwertiges Möbelstück zu liefern, zu Fehlteilen kommen, schicken Sie bitte dieses ausgefüllte Blatt an
Fax.: **+49 3443/434354**
E-Mail: **weissenfels.ersatzteile@pelipal.de**
Bitte beachten Sie, dass Bauteile über 800mm Länge und 350mm Breite direkt bei Ihrem Möbelhändler zu beanstanden sind. Zur Reklamationsbearbeitung ist es unbedingt erforderlich **die Artikelnummer des Schrankes**, welche auf dem Etikett ersichtlich ist und den Markt, wo das Möbel erworben wurde anzugeben. Ausserdem tragen Sie unten bitte die benötigte Stückzahl ein. Viel Spass mit Ihrem neuen Badmöbel! Ihr Pelipal Team

_____ - _____

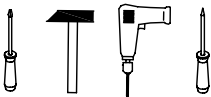

T3 Für den Zusammenbau sind 2 Personen erforderlich.

T4 Montage-Richtzeit 3 Stunden

4 x a ZPL-016X000	Stück	4 x b TBD-26-115X00	Stück	4 x c DÜB-HLZ-008X030	Stück	16 x d EXZENTER-000015	Stück	8 x e SCH-SPA-035X015	Stück
16 x f NAGEL-025X001	Stück	12 x g TRÄ-001-000020		2 x h Griffschrauben	Stück	2 x k Griff	Stück	1 x l SCH-SPA-045X045	Stück
1 x m AUF-001-000070	Stück	16 x n DÜB-SMD-000005	Stück	2 x o SCH-RDK-040X015	Stück	1 x p ADK-AL1-005X008	Stück		Stück

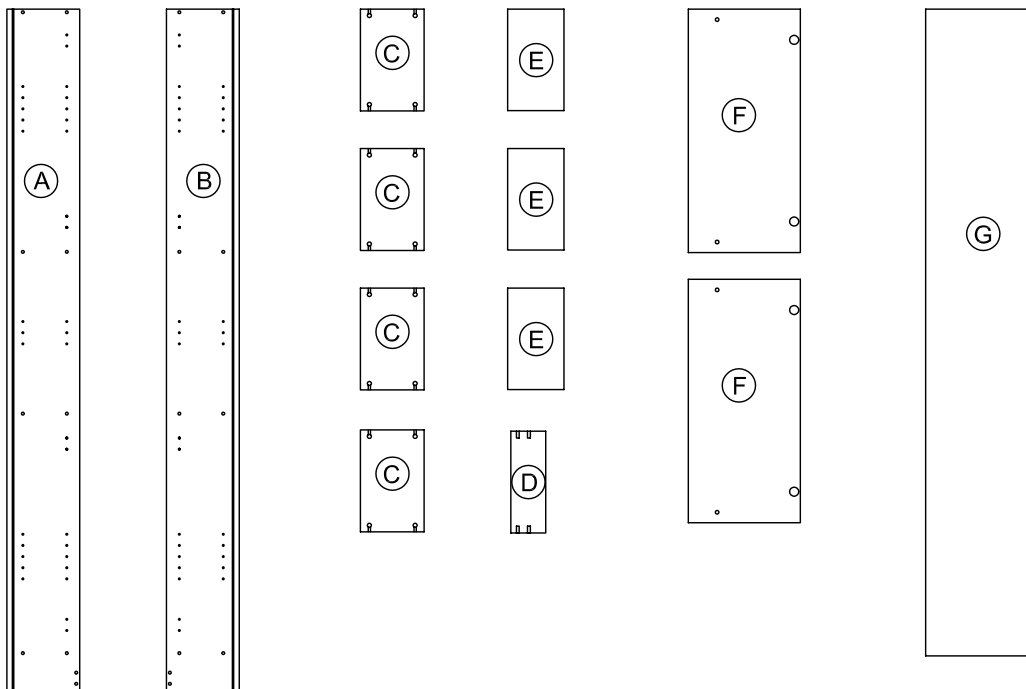

1.

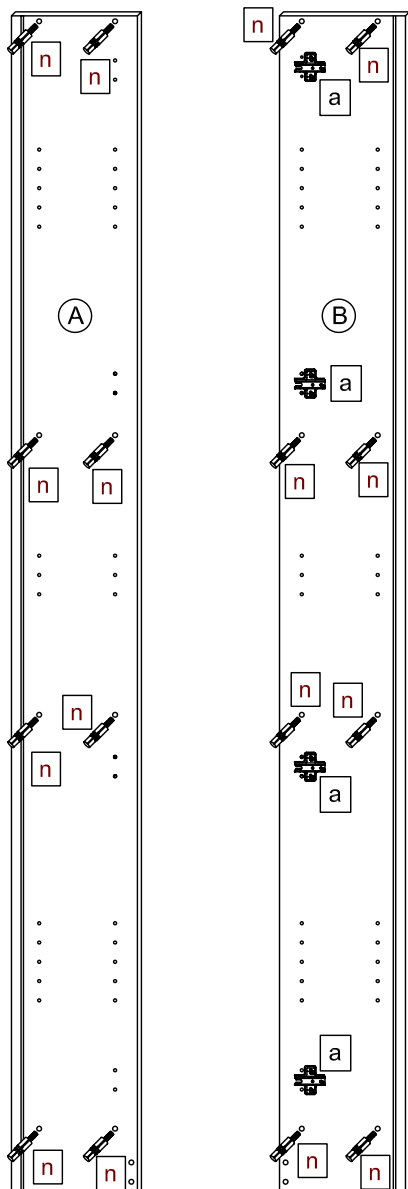
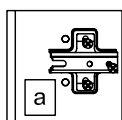
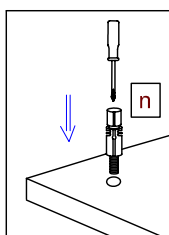
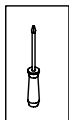

2.

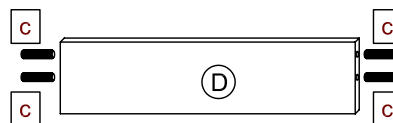
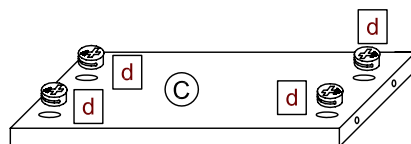

3.

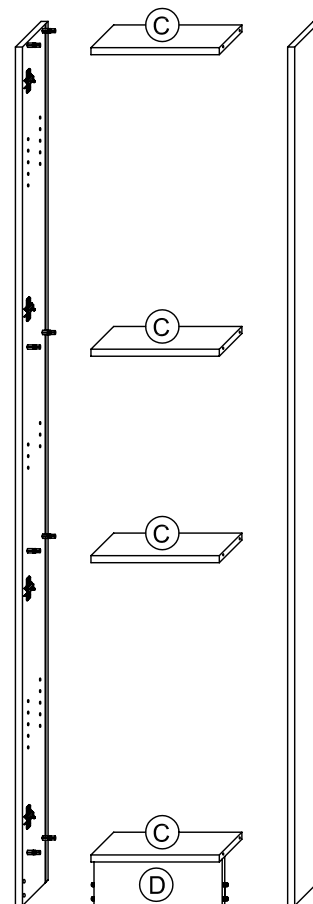
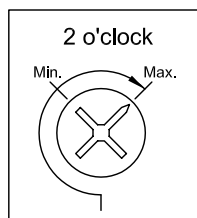
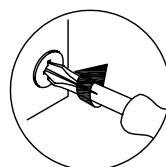
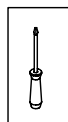

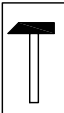
4. 

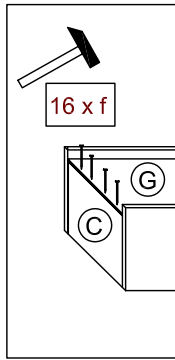
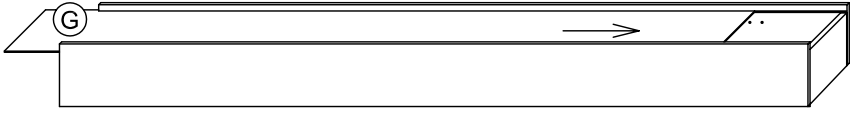

5.

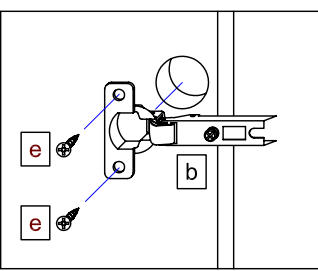
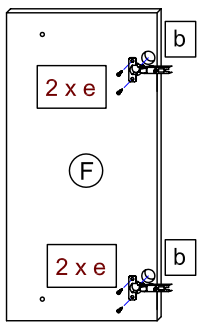
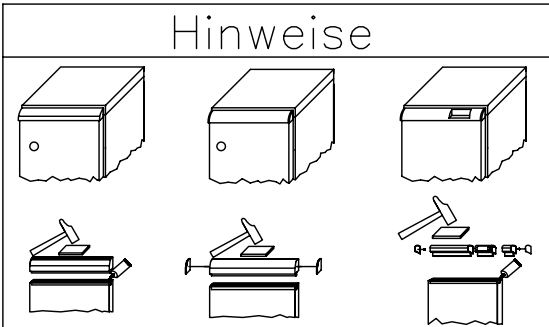
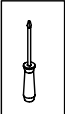

6.

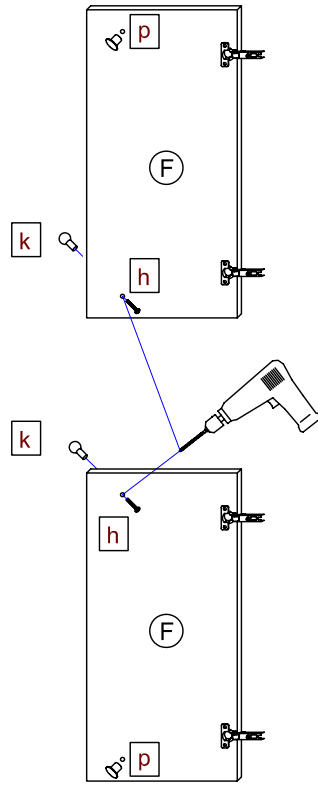
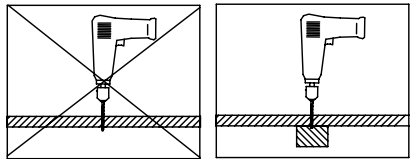
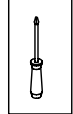

Das Etikett, welches sich unten rechts befindet bitte ausschneiden und auf der Rückwand mit Klebeband (nicht beiliegend) befestigen.

PELIPAL GmbH
 Industriestrasse 12
 33189 Schlangen

6.

T9 Lassen Sie den Schrank nur durch fachkundige Personen mit für die Wand geeignetem Montagematerialien montieren.

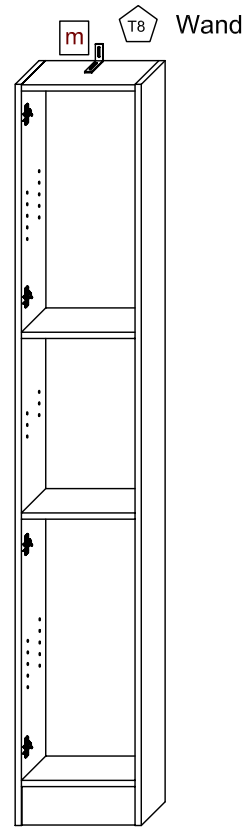
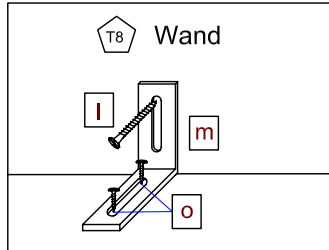

7.

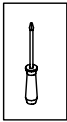

T11 Bei Türmontage das Scharnier einhängen, bis Anschlag öffnen und anschließend festschrauben.

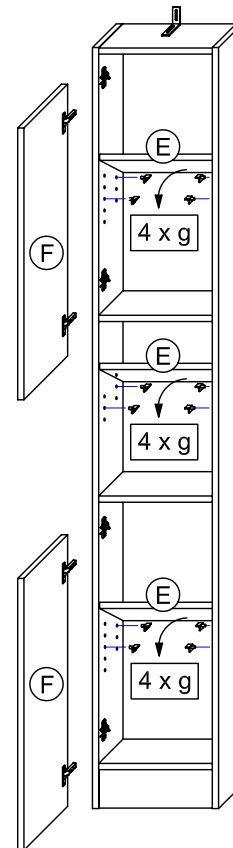
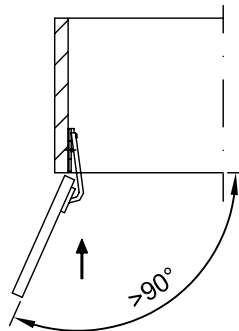
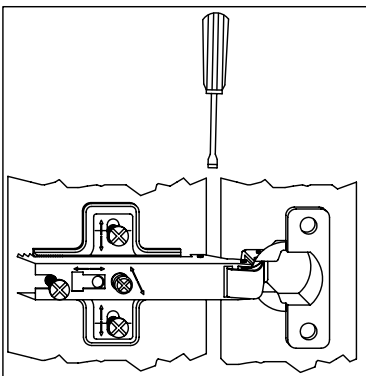

T12 Das Möbel bitte nur mit einem feuchten Tuch reinigen.

-5100 00

4*c

4*g

4*k

E1

E2

12*d

4*h



4*A

4*D

1*B

3*C

8*q

8*b

16*e

16*i

20*f

16*j

1*g

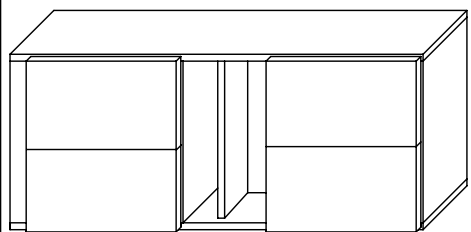
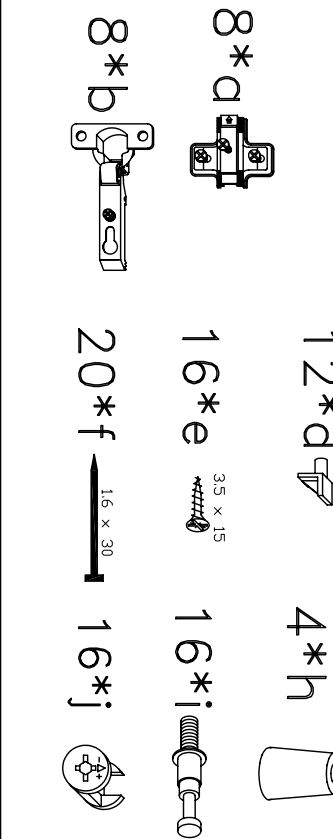
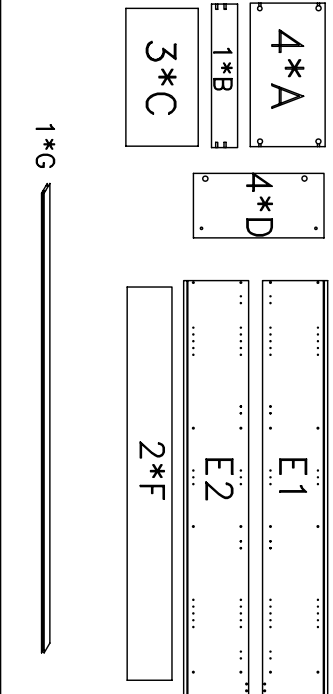

1.

2.

3.

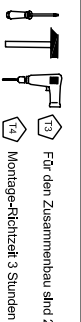
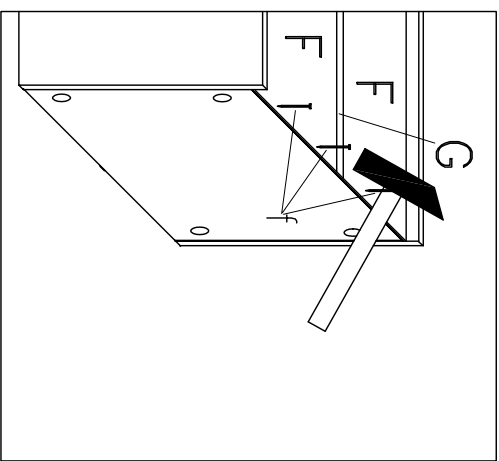
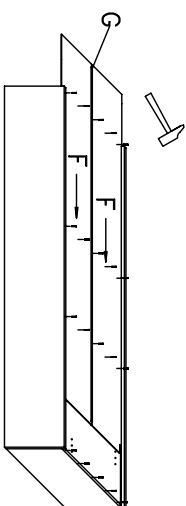
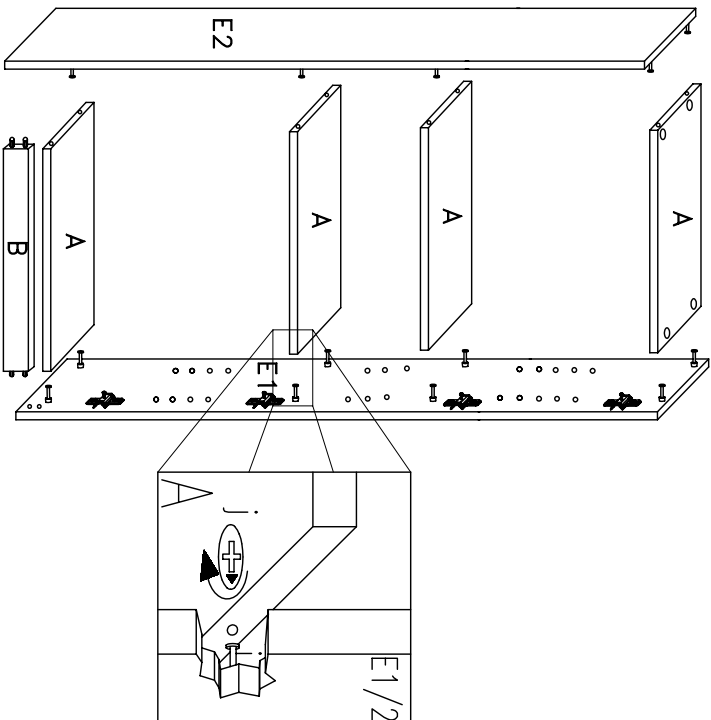
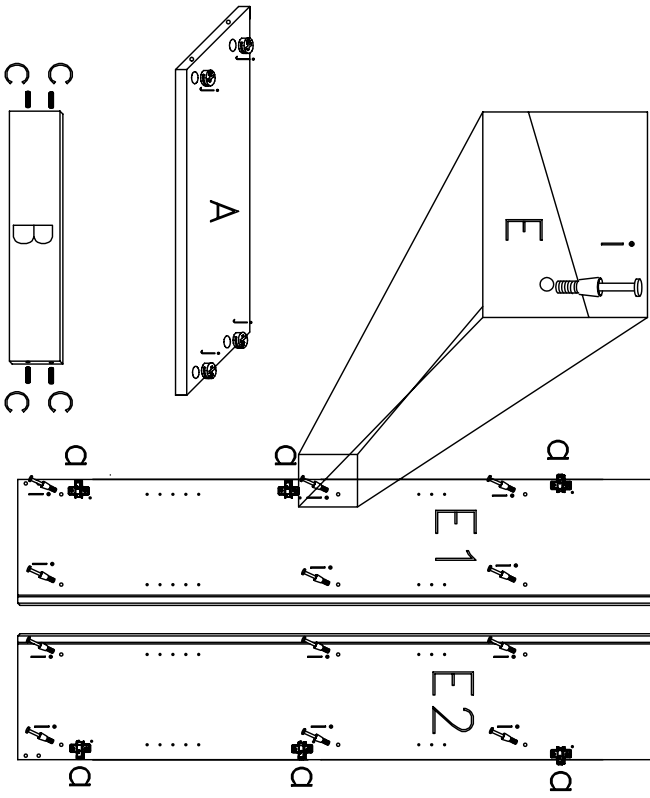
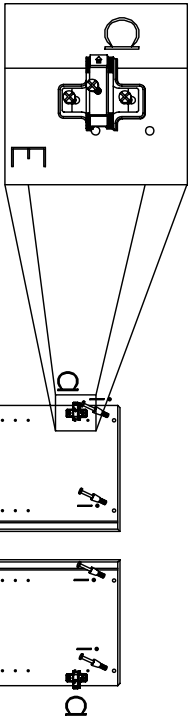

Für den Zusammenbau sind 2 Personen erforderlich.
Montage-Richtzeit 3 Stunden

4.

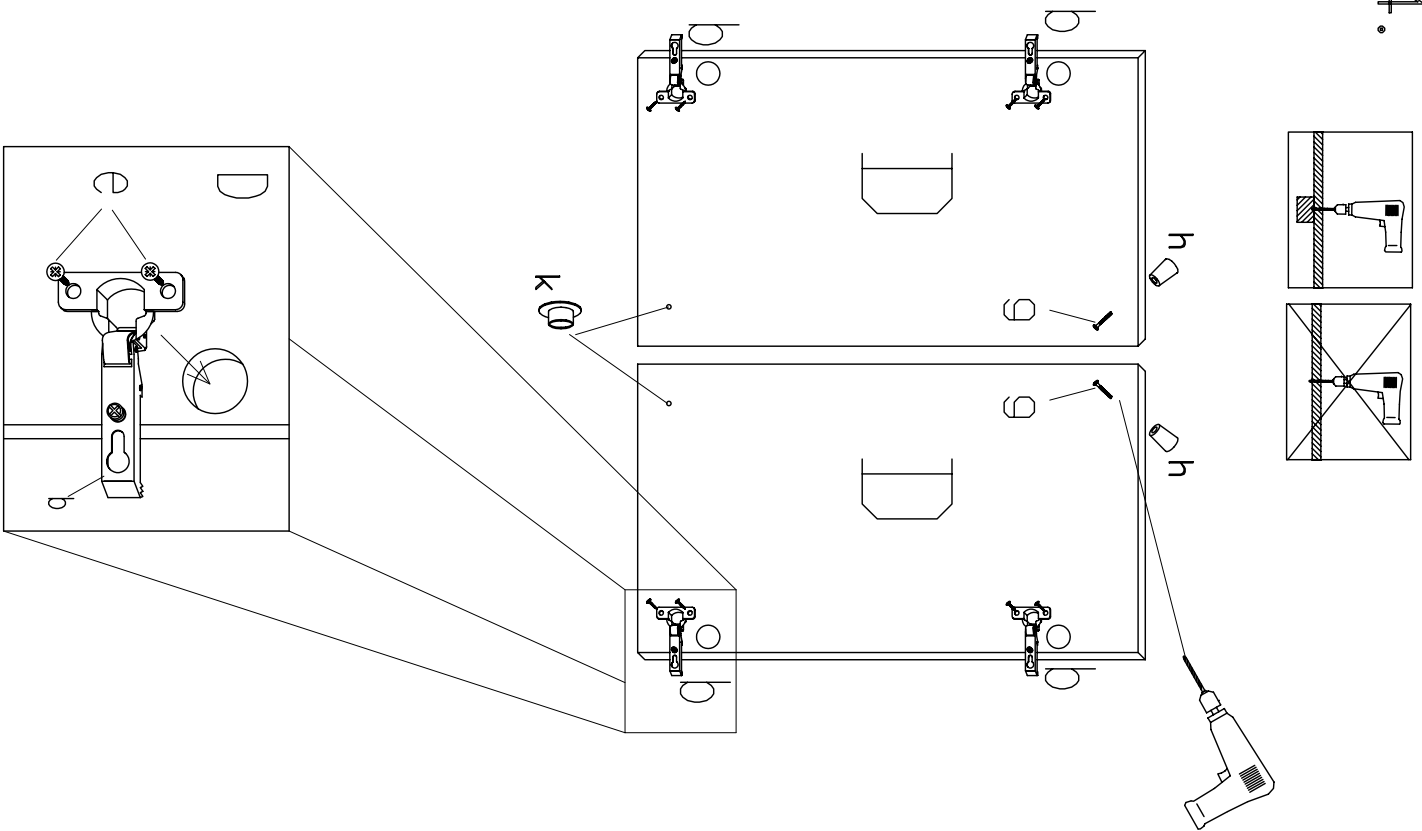

5.

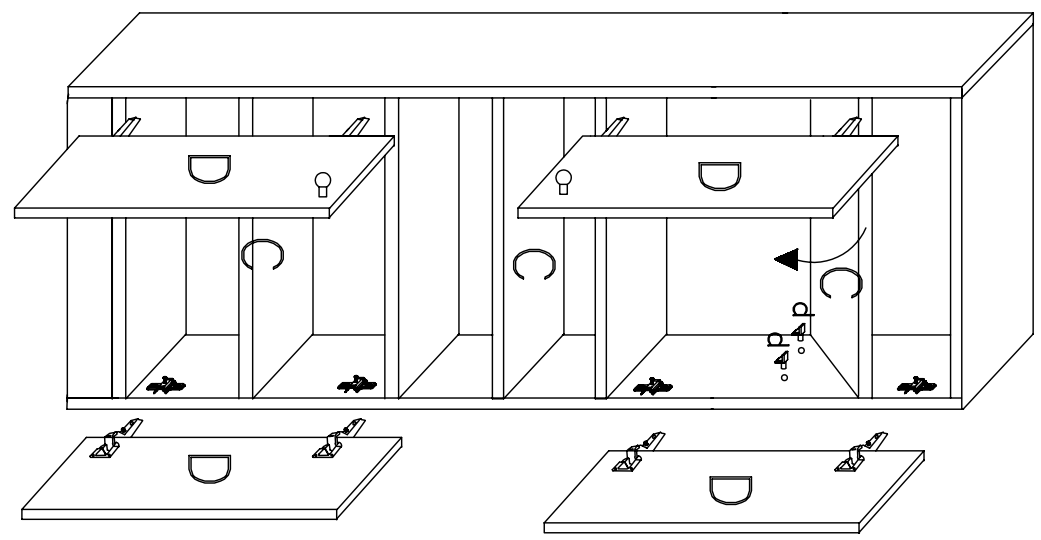
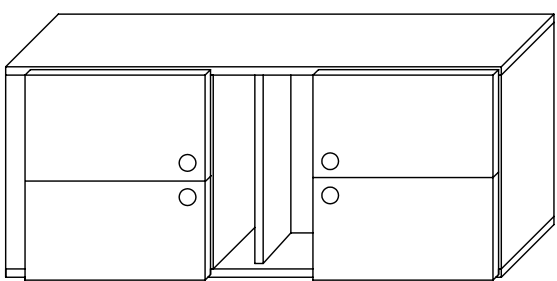

⚠ Bei Türmontage das Scharnier einhängen, bis Anschlag öffnen und anschließend festschrauben.

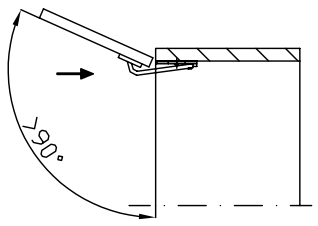
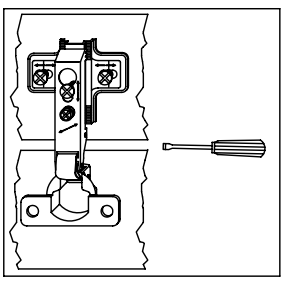

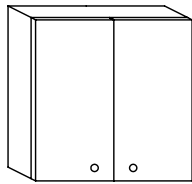

3 _ _ -015030

9 _ _ -127000

T1 Bitte unbedingt ausfüllen!

Name

Strasse

Plz

Ort

Tel.

T2 Sehr geehrte Kunden,

wir freuen uns, dass Sie sich für ein Produkt aus dem Hause Pelipalentschieden haben. Sollte es trotz aller Bemühungen unsererseits, Ihnen ein qualitativ hochwertiges Möbelstück zu liefern, zu Fehlteilen kommen, schicken Sie bitte dieses ausgefüllte Blatt an

Fax.: +49 3443/434354

E-Mail: weissenfels.ersatzteile@pelipal.de

Bitte beachten Sie, dass Bauteile über 800mm Länge und 350mm Breite direkt bei Ihrem Möbelhändler zu beanstanden sind. Zur Reklamationsbearbeitung ist es unbedingt erforderlich **die Artikelnummer des Schrankes**, welche auf dem Etikett ersichtlich ist und den Markt, wo das Möbel erworben wurde anzugeben. Ausserdem tragen Sie unten bitte die benötigte Stückzahl ein. Viel Spass mit Ihrem neuen Badmöbel! Ihr Pelipal Team

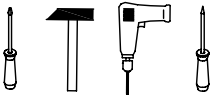

T3 Für den Zusammenbau sind 2 Personen erforderlich.

T4 Montage-Richtzeit 3 Stunden

4 x a ZPL-016X000	Stück	4 x b TBD-26-115X00	Stück	8 x c SCH-SPA-035X015	Stück	8 x d DÜB-SMD-000005	Stück	12 x e NAGEL-025X001	Stück
4 x f SCH-SPA-035X035	Stück	2 x g AUF-001-000020	Stück	8 x h EXZENTER-000015	Stück	2 x k AUF-001-000010	Stück	2 x l ADK-AL1-005X008	Stück
8 x m TRÄ-001-000020	Stück	2 x n Griff	Stück	2 x o Griffschrauben	Stück		Stück		Stück

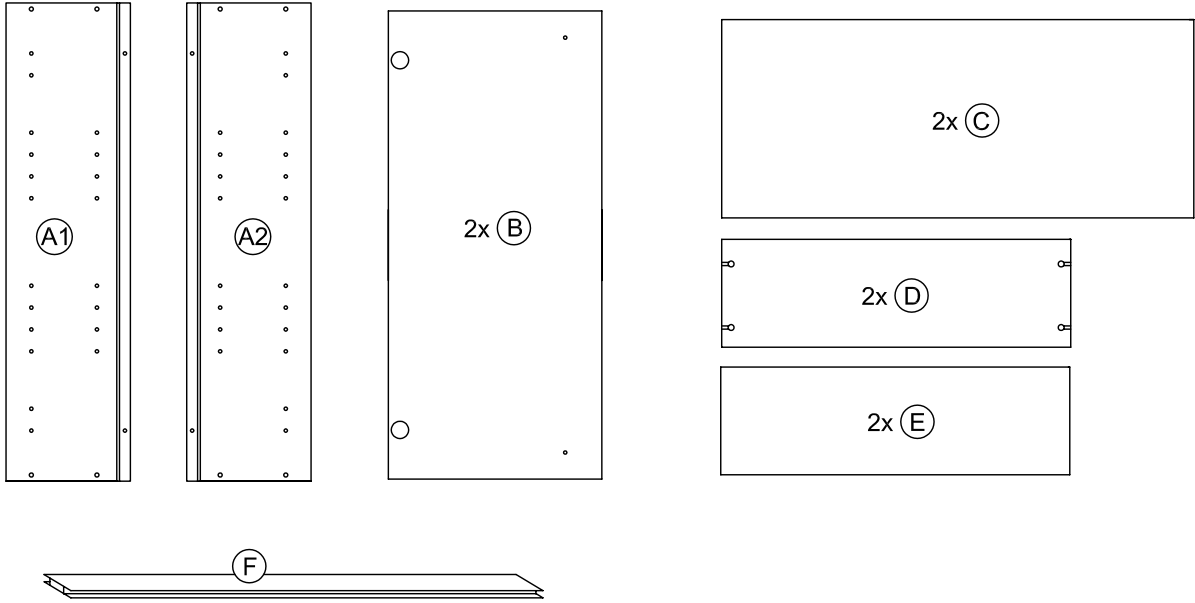

1.

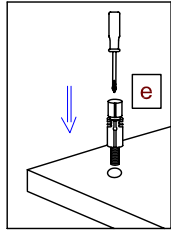
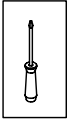

2.

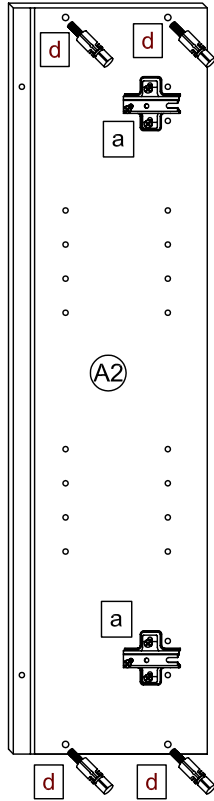
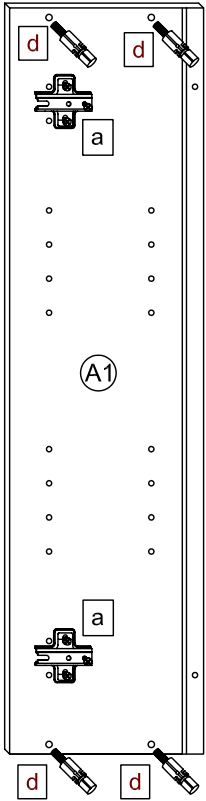
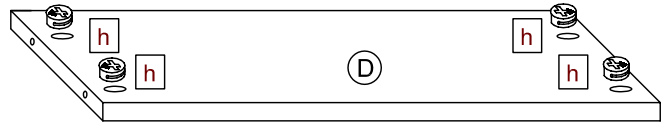

3.

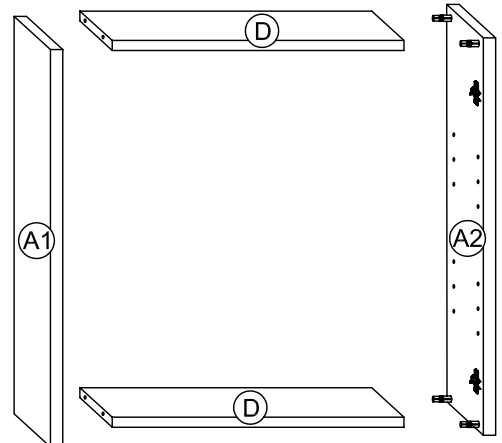
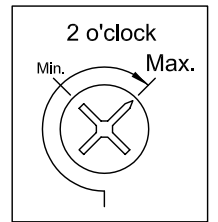
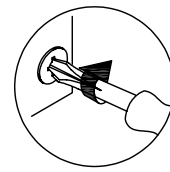
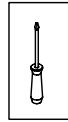

4.

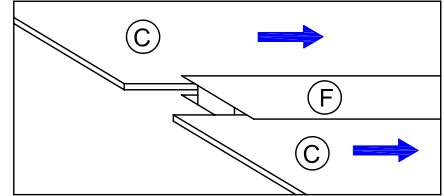
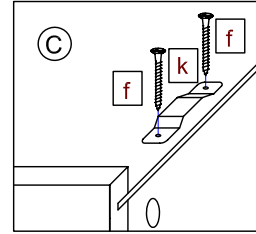
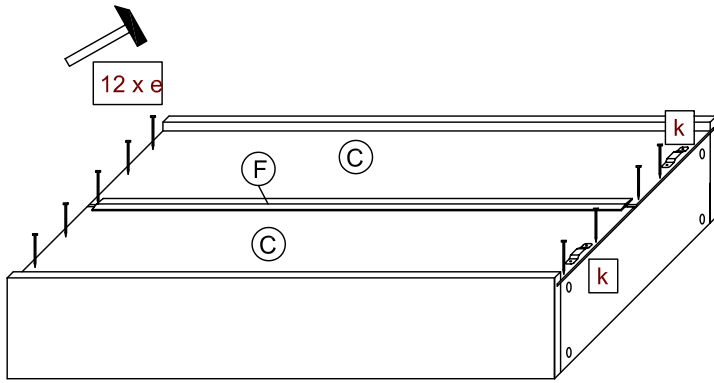
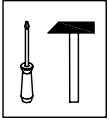

5.

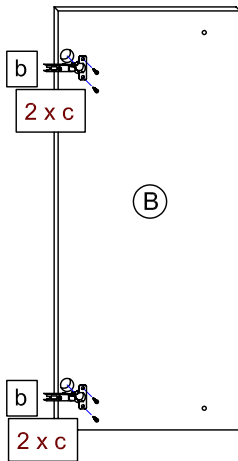
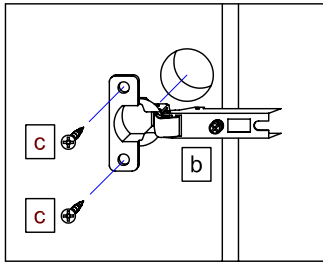
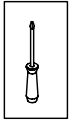

6.

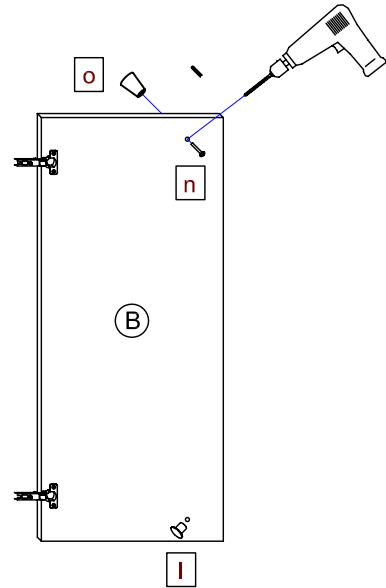
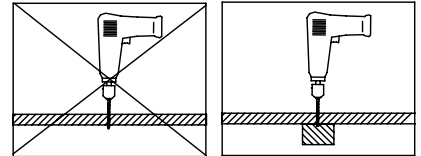
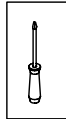

Das Etikett, welches sich unten rechts befindet bitte ausschneiden und auf der Rückwand mit Klebeband (nicht beiliegend) befestigen.

PELIPAL GmbH
 Industriestrasse 12

33189 Schlangen

6.

T9 Lassen Sie den Schrank nur durch fachkundige Personen mit für die Wand geeignetem Montagematerialien montieren.

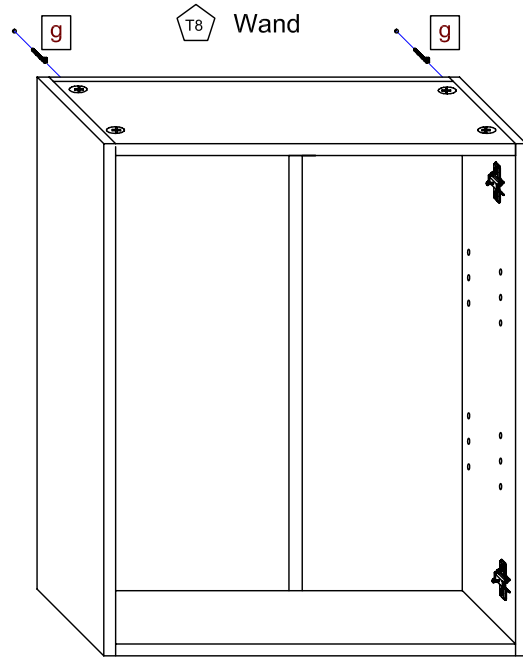

7.

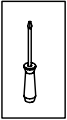



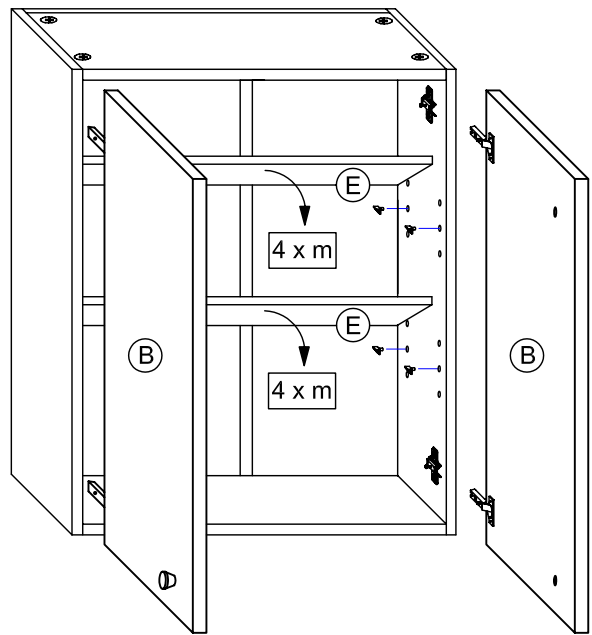
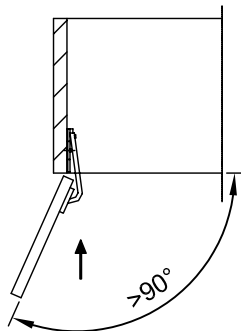
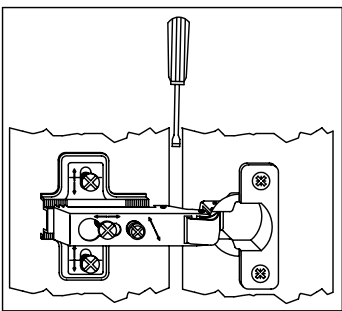



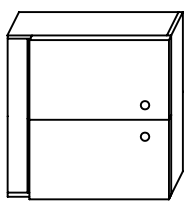

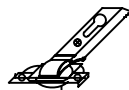

T11 Bei Türmontage das Scharnier einhängen, bis Anschlag öffnen und anschließend festschrauben.

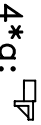

T12 Das Möbel bitte nur mit einem feuchten Tuch reinigen.



— 0400 00

- 4*a: 
- 8*b:  3,5x15
- 4*c: 
- 8*d: 
- 8*e: 
- 4*g: 
- 2*h: 
- 2*i: 
- 2*k: 
- 1*s: 
- 2*l: 

4*n: 

⚠ Für den Zusammenbau sind 2 Personen erforderlich.
 ⚠ Montage-Richtzeit: 3 Stunden

- A1
- A2
- 2*B
- 2*C
- 1*D
- 1*E
- 1*F
- 1*G



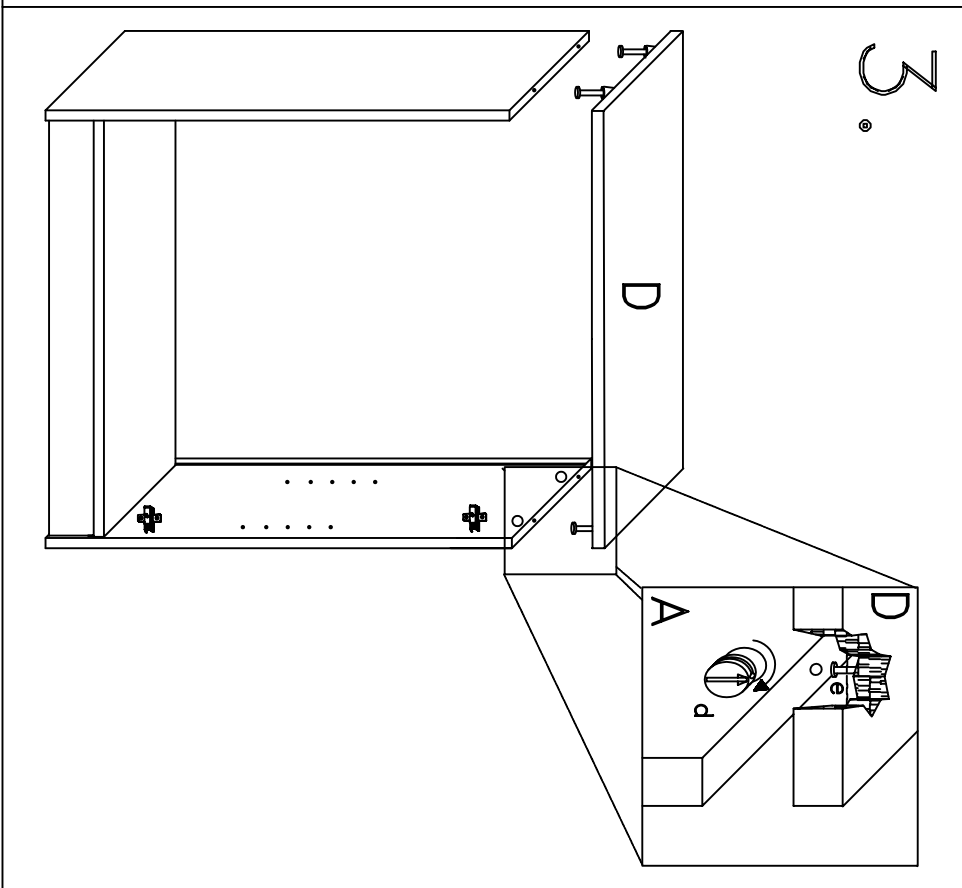
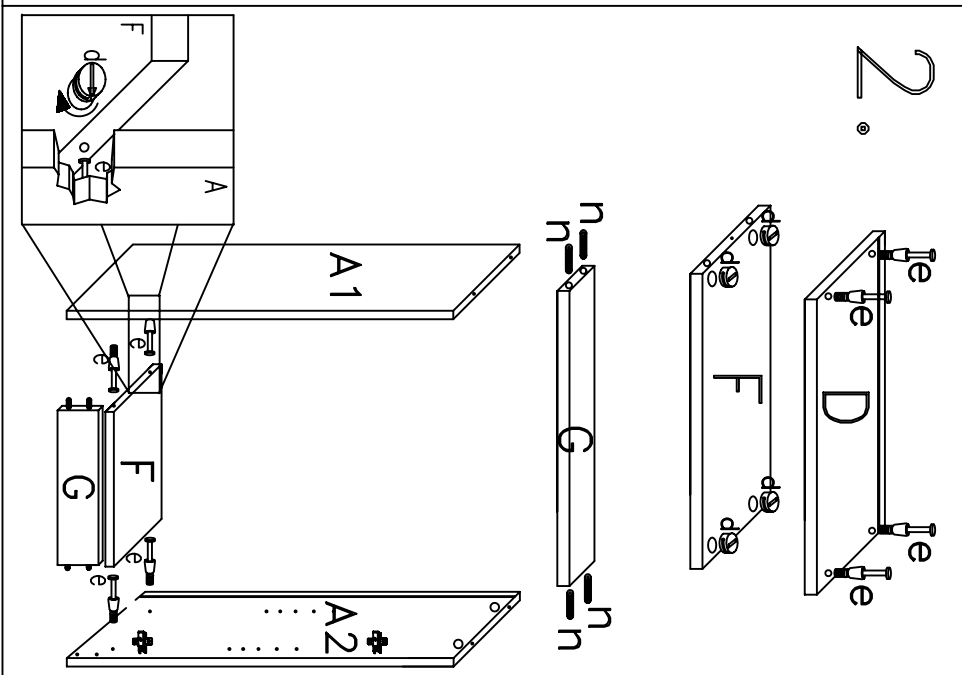
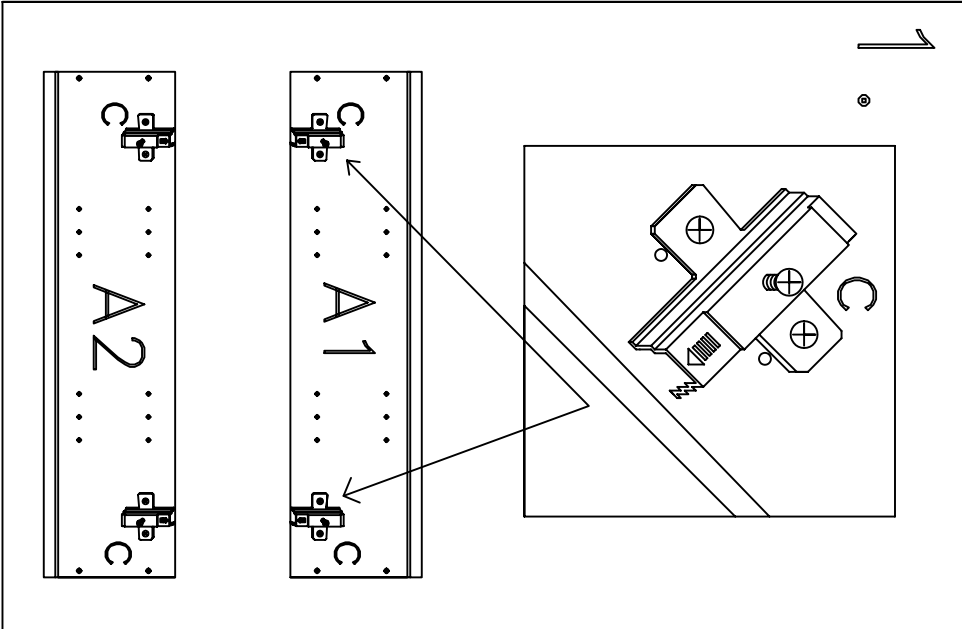

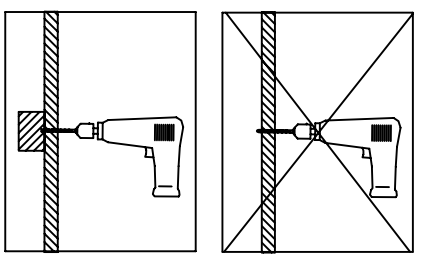
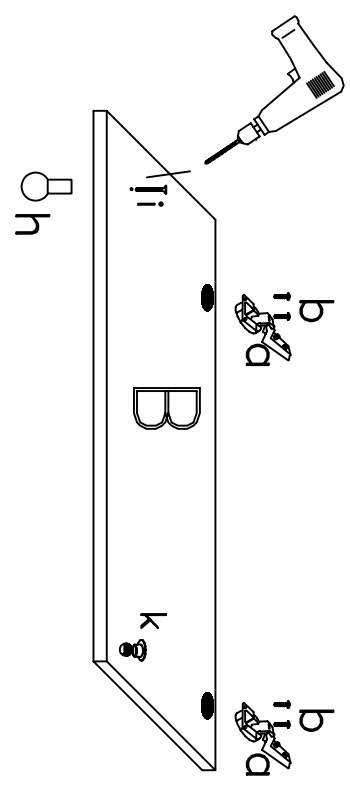
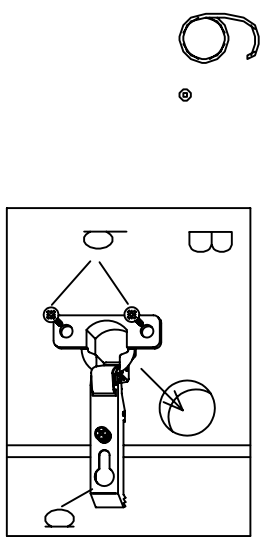
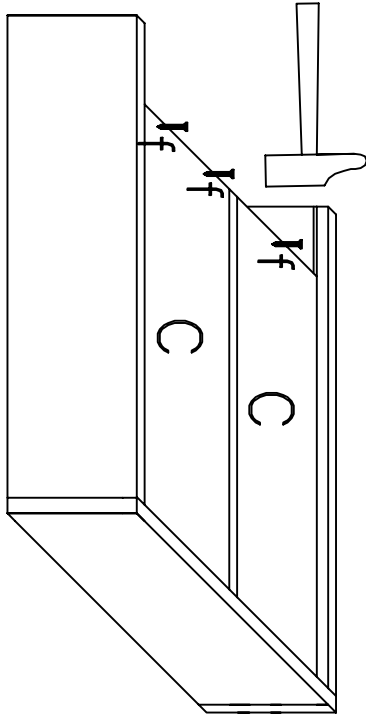
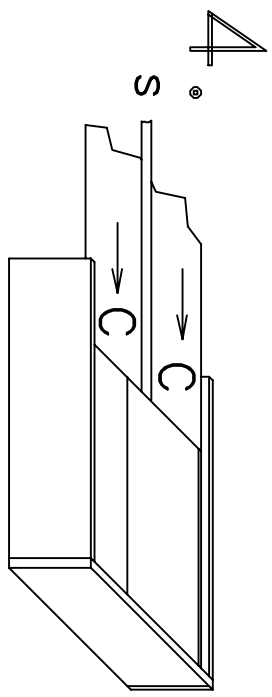
5.

Hinweise

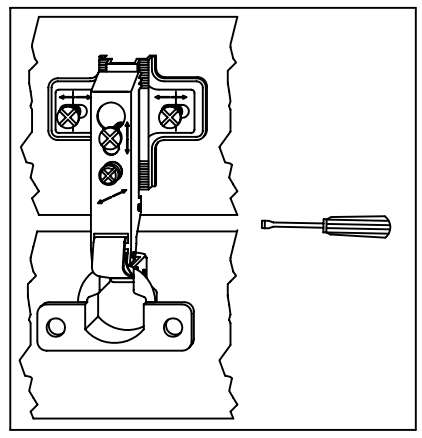
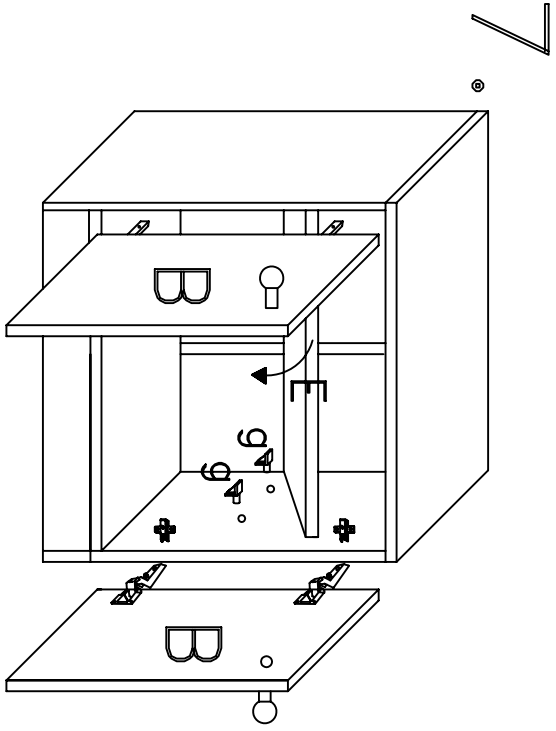
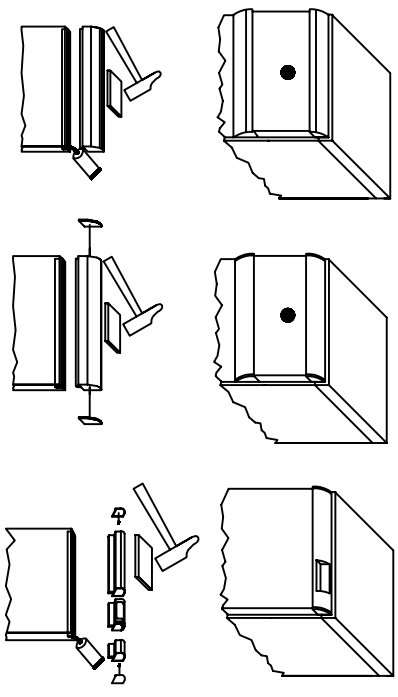

(T17) Bei Türmontage das Scharnier einhängen, bis Anschlag öffnen und anschließend festschrauben.

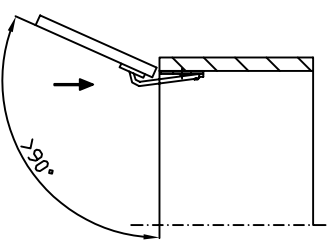

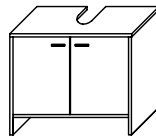
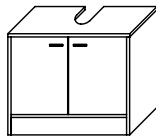

3__-016017 / 3__-166017
9__-170000 / 9__-170600

T1 Bitte unbedingt ausfüllen!

Name _____

Strasse _____

Plz _____ Ort _____

Tel. _____

T2 Sehr geehrte Kunden,

wir freuen uns, dass Sie sich für ein Produkt aus dem Hause Pelipalentschieden haben. Sollte es trotz aller Bemühungen unsererseits, Ihnen ein qualitativ hochwertiges Möbelstück zu liefern, zu Fehlteilen kommen, schicken Sie bitte dieses ausgefüllte Blatt an

Fax.: +49 3443/434354

E-Mail: weissenfels.ersatzteile@pelipal.de

Bitte beachten Sie, dass Bauteile über 800mm Länge und 350mm Breite direkt bei Ihrem Möbelhändler zu beanstanden sind. Zur Reklamationsbearbeitung ist es unbedingt erforderlich **die Artikelnummer des Schrankes**, welche auf dem Etikett ersichtlich ist und den Markt, wo das Möbel erworben wurde anzugeben. Ausserdem tragen Sie unten bitte die benötigte Stückzahl ein. Viel Spass mit Ihrem neuen Badmöbel! Ihr Pelipal Team

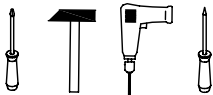

T3 Für den Zusammenbau sind 2 Personen erforderlich.

T4 Montage-Richtzeit 3 Stunden

4 x a TBD-26-115X00	Stück	4 x b ZPL-016X000	Stück	8 x c SCH-SPA-035X015	Stück	8 x d DÜB-SMD-000005	Stück	8 x e EXZENTER-000015	Stück
4 x f Stück	Stück	2 x g Griff	Stück	6 x h NAGEL-025X001	Stück	4 x j DÜB-HLZ-008X030	Stück	4 x k ADK-AL1-005X008	Stück

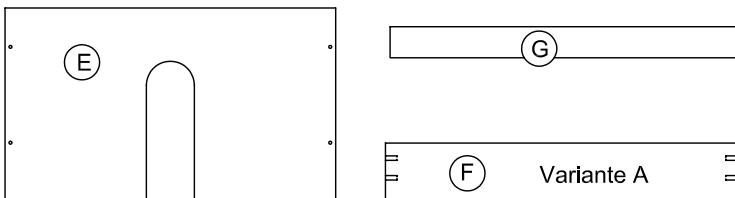
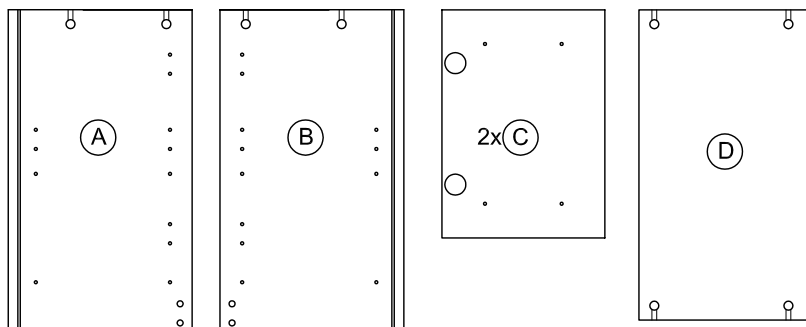

2 x l RWD-KEI-000050	Stück	2 x m SCH-SPA-035X020	Stück
1 x n Kantenprofil			Stück
			Stück

1.

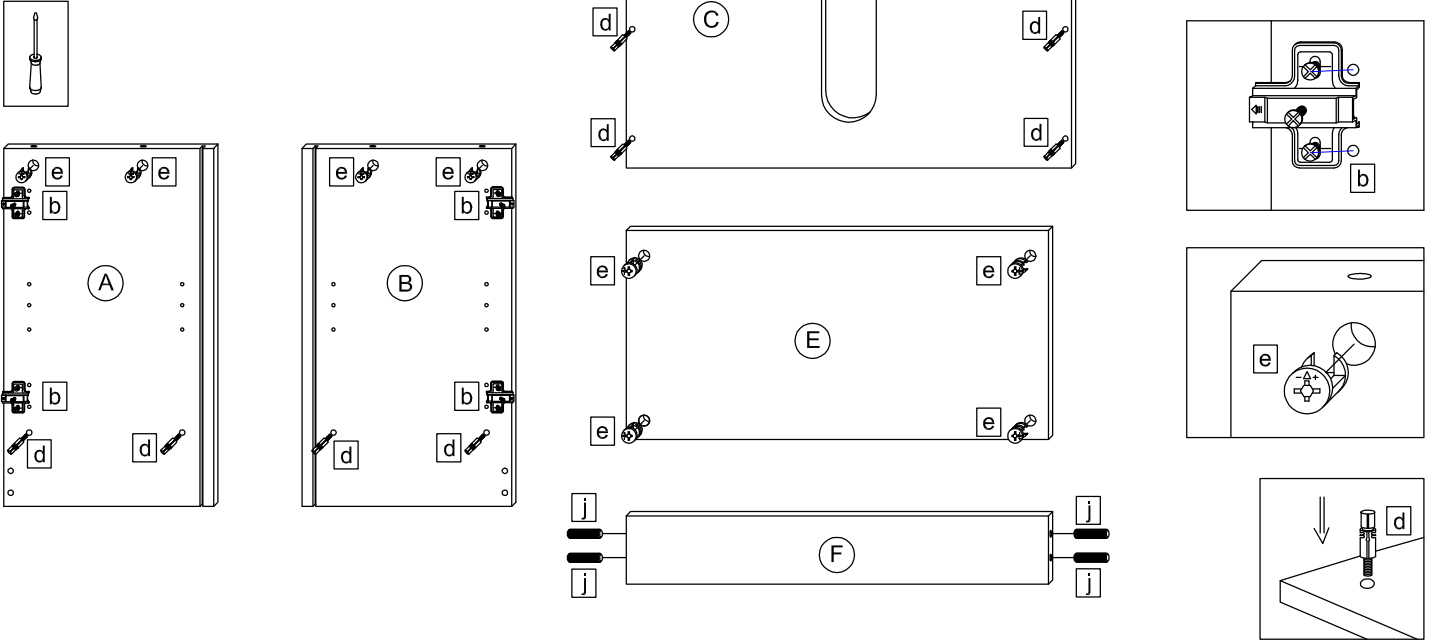

2.

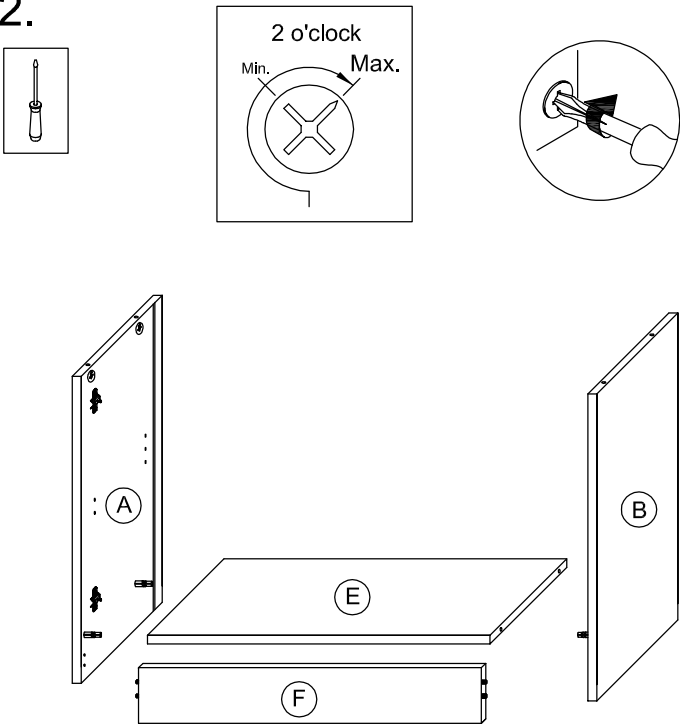

3.

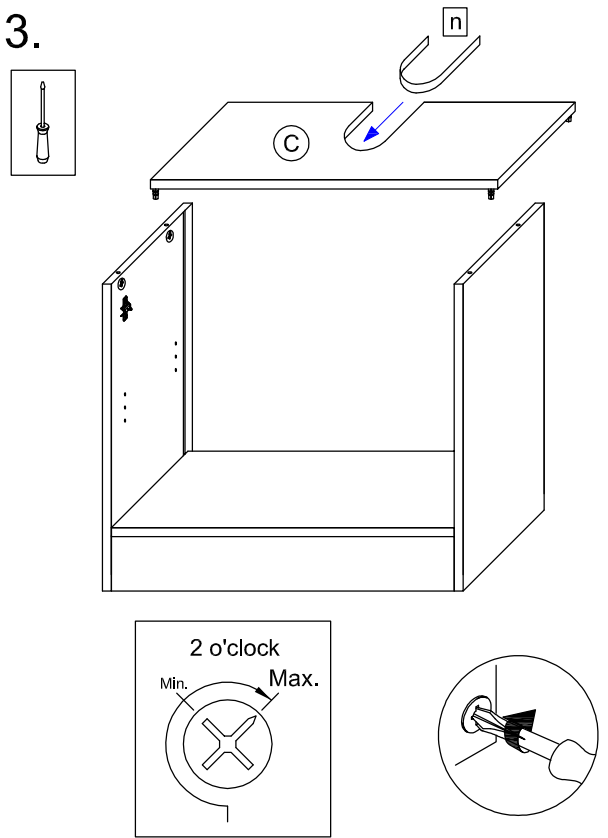

4.

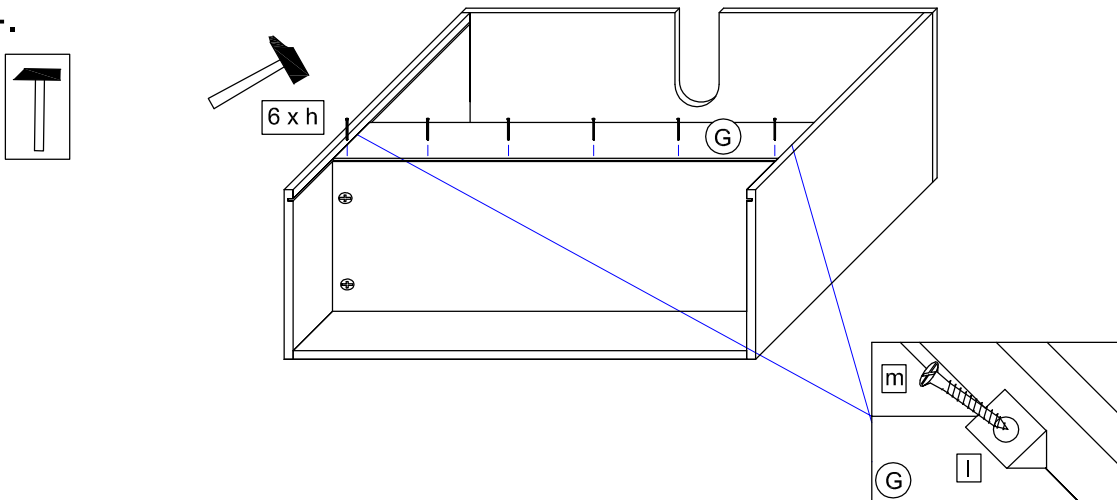

5.

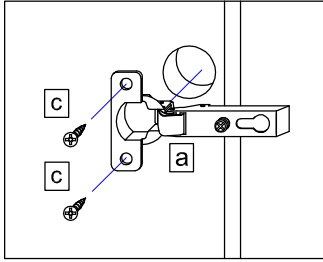
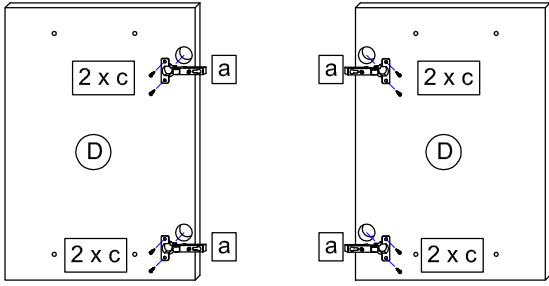
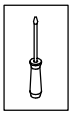

6.

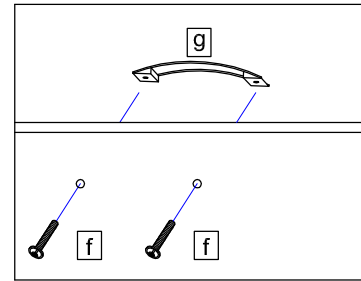
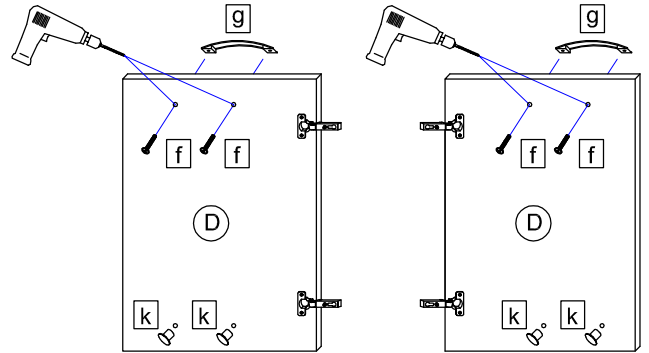
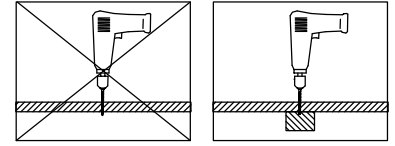
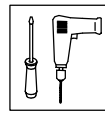

7.

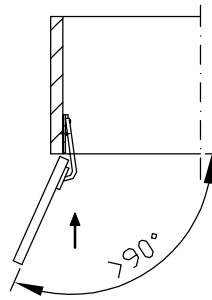
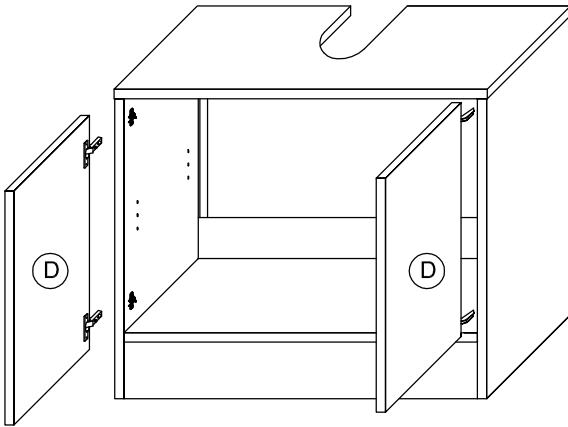
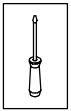

T11 Bei Türmontage das Scharnier einhängen, bis Anschlag öffnen und anschließend festschrauben.

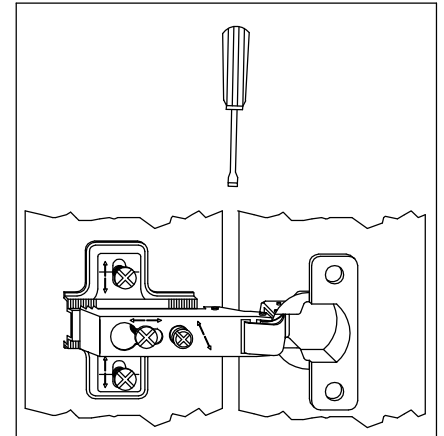

T12 Das Möbel bitte nur mit einem feuchten Tuch reinigen.



T5 Das Etikett, welches sich unten rechts befindet bitte ausschneiden und auf der Rückwand mit Klebeband (nicht beiliegend) befestigen.

PELIPAL GmbH
 Industriestrasse 12

33189 Schlangen
 Germany

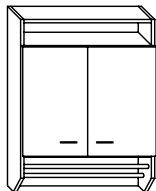

T1 Bitte unbedingt ausfüllen!

Name _____

Strasse _____

Plz _____ Ort _____

Tel. _____

T2 Sehr geehrte Kunden,
wir freuen uns, dass Sie sich für ein Produkt aus dem Hause Pelipalentschieden haben. Sollte es trotz aller Bemühungen unsererseits, Ihnen ein qualitativ hochwertiges Möbelstück zu liefern, zu Fehlteilen kommen, schicken Sie bitte dieses ausgefüllte Blatt an

Fax.: +49 3443/434354

E-Mail: weissenfels.ersatzteile@pelipal.de



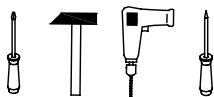





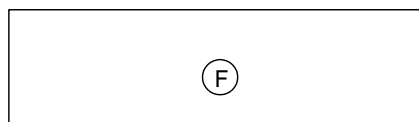
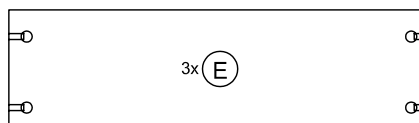
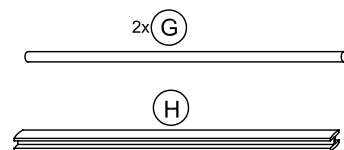
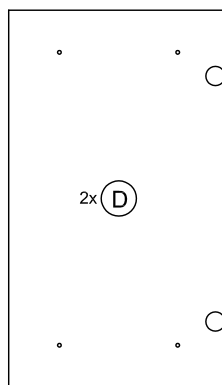
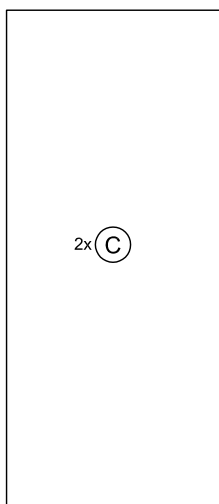
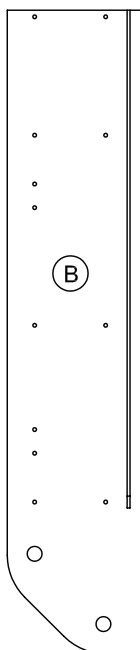
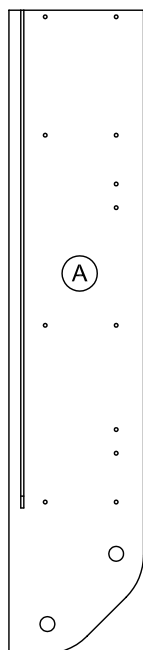

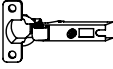

Bitte beachten Sie, dass Bauteile über 800mm Länge und 350mm Breite direkt bei Ihrem Möbelhändler zu beanstanden sind. Zur Reklamationsbearbeitung ist es unbedingt erforderlich **die Artikelnummer des Schrankes**, welche auf dem Etikett ersichtlich ist und den Markt, wo das Möbel erworben wurde anzugeben. Ausserdem tragen Sie unten bitte die benötigte Stückzahl ein. Viel Spass mit Ihrem neuen Badmöbel! Ihr Pelipal Team

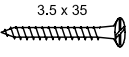

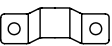
T3 Für den Zusammenbau sind 2 Personen erforderlich.

T4 Montage-Richtzeit 3 Stunden

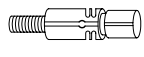

4 x a  ZPL-016X000	Stück	4 x b  TBD-26-115X00	Stück	8 x c  3,5 x 15 SCH-SPA-035X015	Stück	12 x d  EXZENTER-000015	Stück	MOT-Z0451S2 A4 Datum 04/08/08	
8 x e  NAGEL-025X001	Stück	4 x f  3,5 x 35 SCH-SPA-035X035	Stück	2 x g  AUF-001-000020	Stück	2 x i  AUF-001-000010	Stück		
4 x j  TRÄ-001-000020	Stück	2 x k  GRI-160-335010	Stück	4 x l  M4 x 24 SCH-KNO-M04X024	Stück	12 x m  DÜB-SMD-000005	Stück	4 x n  5 x 8 ADK-AL1-005X008	Stück

1.

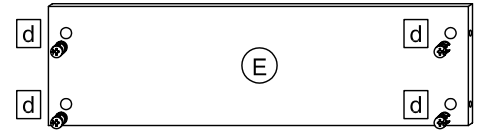
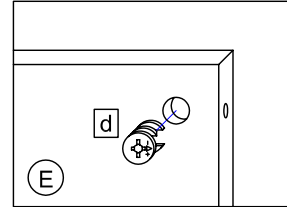
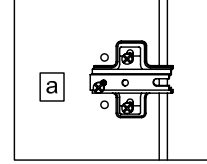
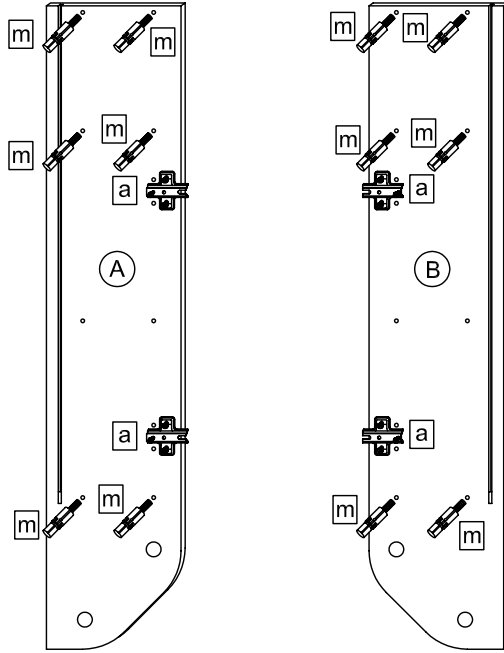
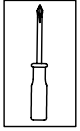

2.

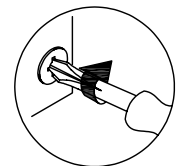
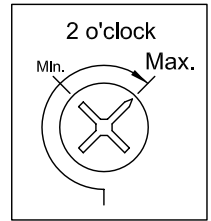
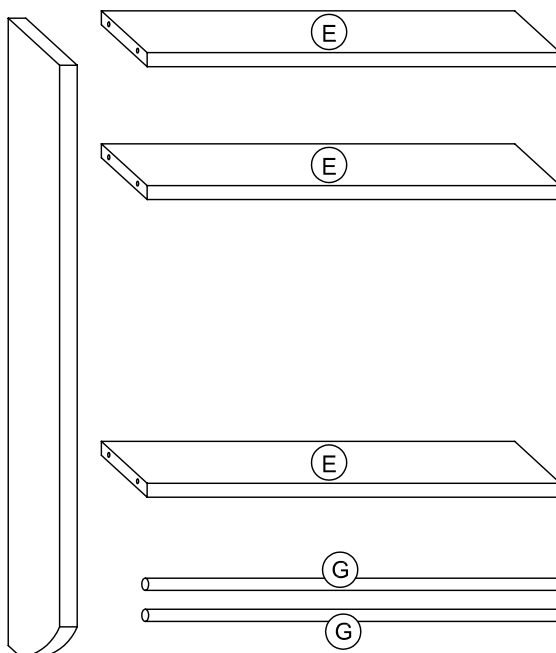
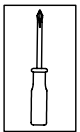

3.

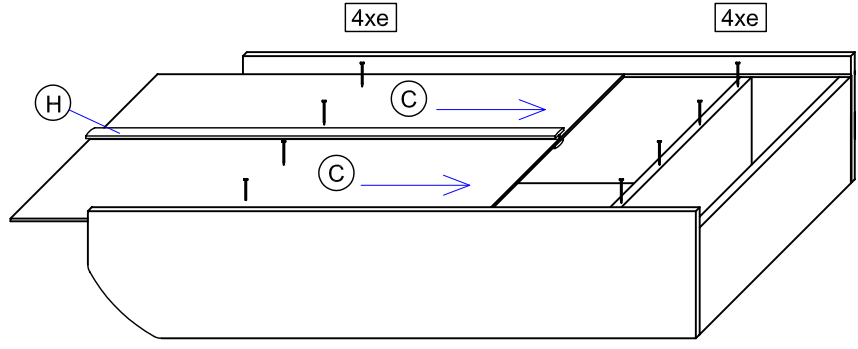
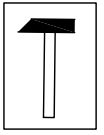

4.

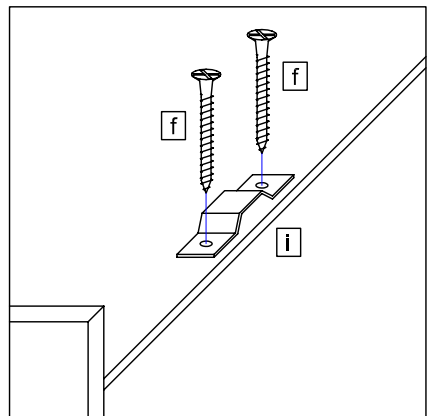
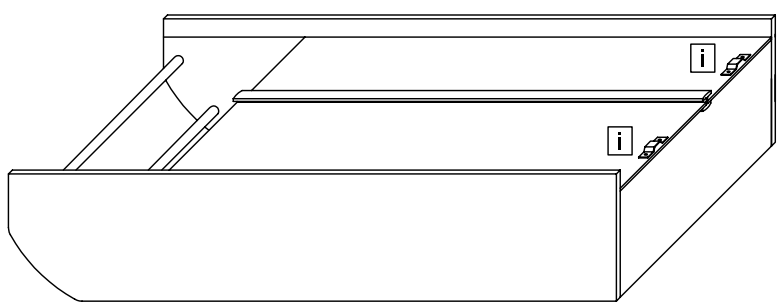
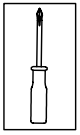

Das Etikett, welches sich unten rechts befindet bitte ausschneiden und auf der Rückwand mit Klebeband (nicht beiliegend) befestigen.

PELIPAL GmbH
Industriestrasse 12
33189 Schlangen

6.

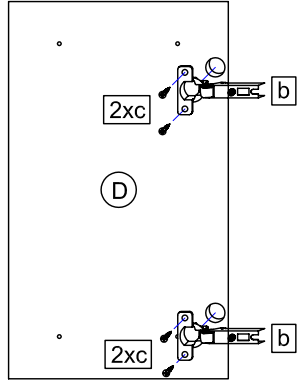
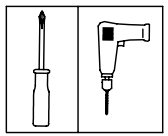

7.

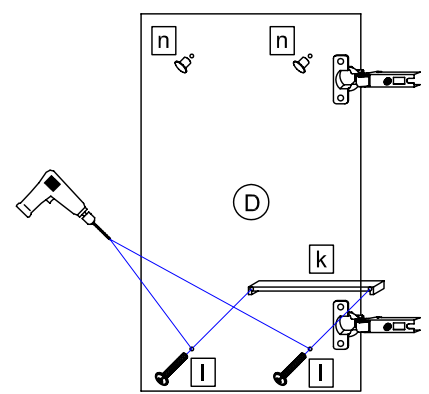
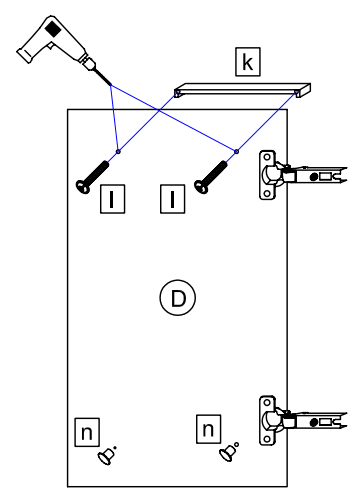
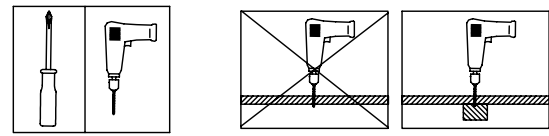

8.

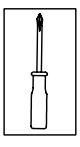

T9 Lassen Sie den Schrank nur durch fachkundige Personen mit für die Wand geeignetem Montagematerialien montieren.

T8 Wand

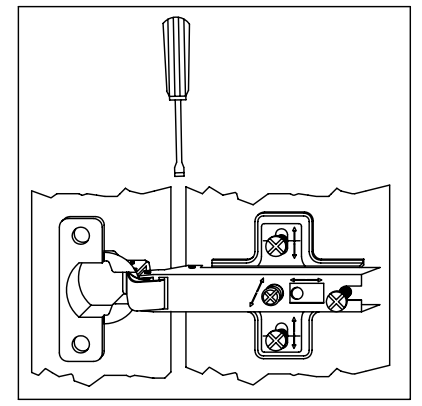
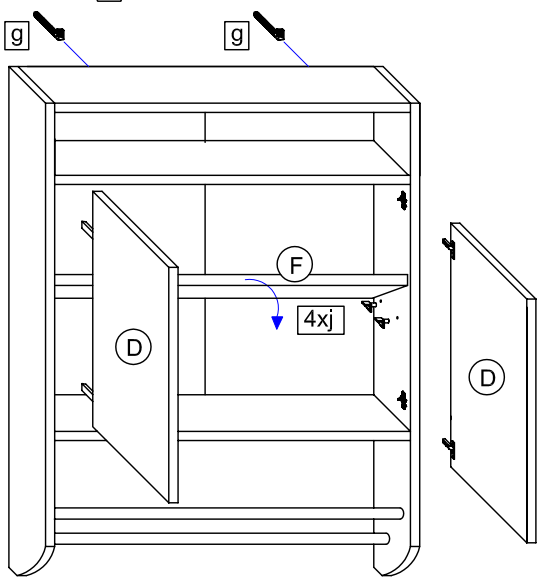

T11 Bei Türmontage das Scharnier einhängen, bis Anschlag öffnen und anschließend festschrauben.

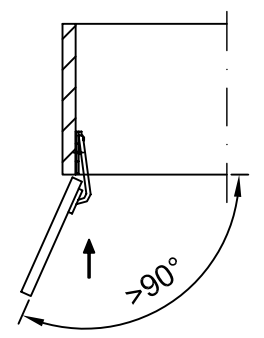

T12 Das Möbel bitte nur mit einem feuchten Tuch reinigen.